

Vorarlberg Magazine

The poesy of the mountains

About a theatre where
Mother Nature provides
the special effects

Wild water

How it thunders and
sings – about its beauty
and force

Meadow motley

A championship where
biodiversity is the name
of the game

Poetry in Nature

Alma

Why Alma has the most award-winning alpine and mountain cheese.

Only unprocessed hay milk is used to make the famous cheese specialties from Vorarlberg in the small Alma alpine dairies and on the dairy alps. Continuing in the tradition of yesteryear, the Alpine dairymen make their Alma Mountain Cheese PDO and Alma Alpine Cheese in massive copper vats by hand.



Contents

Welcome to Vorarlberg! This magazine is dedicated to everything to do with the enjoyment of nature. We are presenting you with unforgettable experiences of the countryside, special spots and cultural projects. Use all your senses to discover the state of Vorarlberg, located between Lake Constance and the summits of majestic mountains.



4 Nature that moves us
Vorarlberg locals and their life projects, including lots of tips for outings



20

Streichbrunnen alp
Visiting the Meadow Champions in the Bregenzerwald



Read the digital version of the magazine

The Vorarlberg Magazine is also available as an e-magazine, featuring videos, slide shows, 360-degree photos and interactive elements.

Or as a magazine for smartphones and computers. All links and videos are available from:

 www.vorarlberg.travel/magazine

30 Waterscapes
Montafon – a hike in the mountains around the Silvretta

04 Proudly presenting: our countryside

Eight Vorarlberg locals tell their story

16 Gallery

All roads lead to the enjoyment of nature

20 Meadow motley

A plant paradise in the Bregenzerwald

28 Hiking is the best medicine

Psychiatrist Reinhard Haller on the positive effects of exercise in the great outdoors

30 It flows. It foams.

About the power of water in the Montafon



38 It was the tawny owl ...

"Shakespeare on the Mountain" brings theatre to the Muttersberg natural arena

44 Tips – outings of an artistic and cultural nature

46 The mini jungle on Lake Constance

Journeys of discovery in the Rhine delta

54 My favourite place

A winter's tale by photographer Sepp Mallaun

60 Tips – winter enjoyment

62 Heaven on earth

How light artist James Turrell is planning a Skyspace in Lech

68 In the labyrinth of stones

Hike to the Gottesacker plateau

74 Information – how to get here, imprint





“Our walk is an appeal to take it slowly, to examine things in detail, to take a second look at things”, explains Daniela Egger. Working together with sculptor Daniel Kocher, the author native to Bregenz has developed the Green Ring. The Green Ring is a hike around Lech Züers am Arlberg which, in several stages, takes three days.



Every person from Lech has a stone

Out and about, hikers encounter art installations incorporated in the landscape, often concealed. Daniela Egger wrote the tales about them and has made a compendium of them published as a literary hiking guide.

And so she sets off on the walk to an amusing, cleverly staged modern world of legends based on old stories. At the Libellensee – the dragonfly lake – for instance, mysterious gases escape from the water. The question is: do they still have such a rejuvenating effect as they used to?

Her tip: “The Green Puzzle Ring, which goes from Lech to the Rud alp: with the aid of a book, adults and children get to put their heads together to solve puzzles and riddles along the way. A hut serving refreshments and a large water playground await you at the top.”



Daniela Egger explains her project in the video – the QR code takes you there.

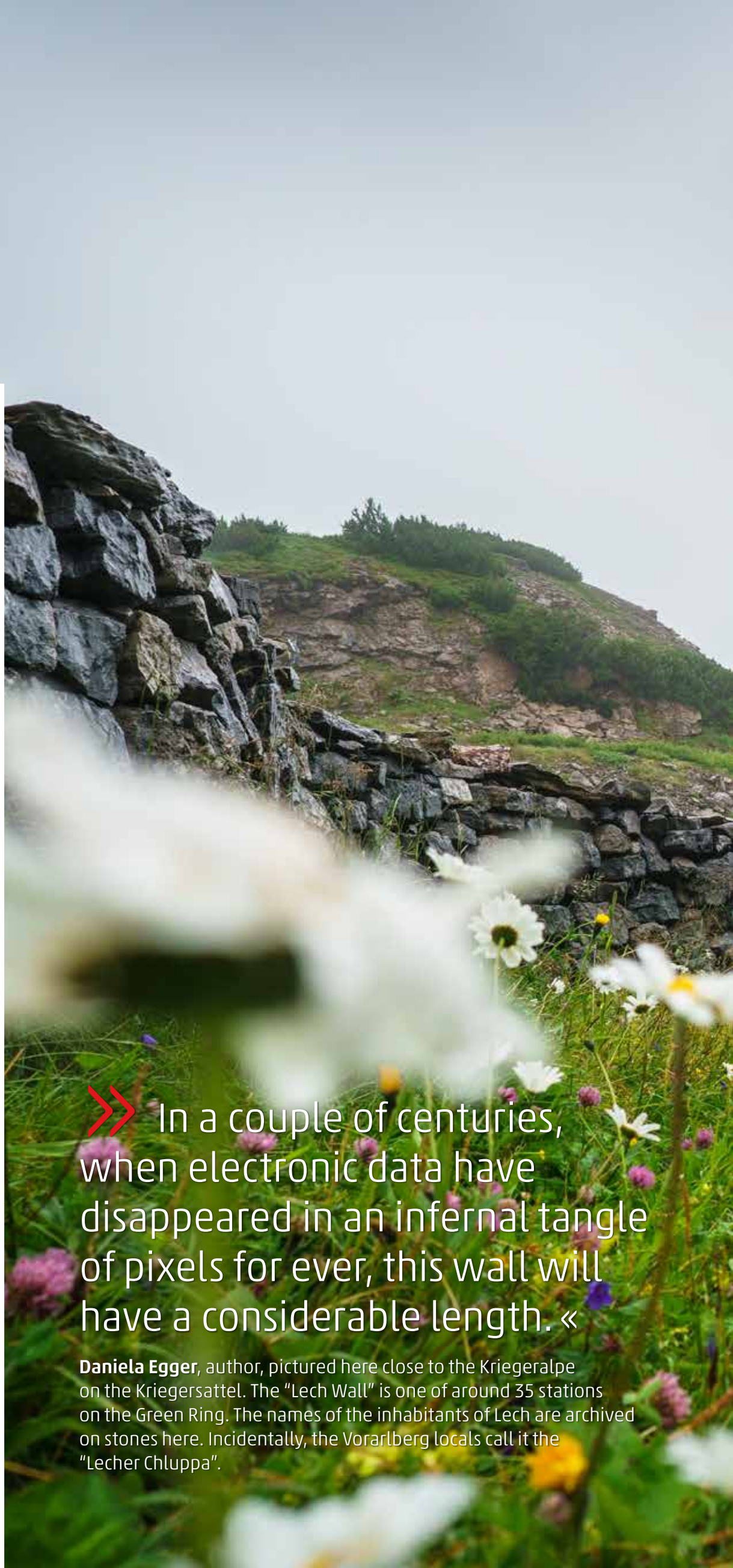

» In a couple of centuries, when electronic data have disappeared in an infernal tangle of pixels for ever, this wall will have a considerable length. «

Daniela Egger, author, pictured here close to the Kriegeralpe on the Kriegersattel. The “Lech Wall” is one of around 35 stations on the Green Ring. The names of the inhabitants of Lech are archived on stones here. Incidentally, the Vorarlberg locals call it the “Lecher Chluppa”.

Proudly presenting: our countryside

On slow hiking, mountains in motion and special places:
eight Vorarlberg locals talk about which life projects
are currently meaningful to them – and where you can
experience them for yourself



“I love the surrounding mountains and the vastness, the unspoilt view of nature”, says Konrad Stadelmann as he gazes across the green valley. He spent five years of his life as the mayor of Sibratsgfäll. Today, in his role as local councillor, he looks after the welfare of the village.

In 1999, the idyllic mountain village in the Bregenzerwald was affected by a gigantic landslide: on an area of around 1.6 square kilometres, the mountainsides on the Rindberg plot started moving inexorably, with 18 buildings sliding down to the valley, some houses moving from their original spot by up to 240 metres.



Loves Sibratsgfäll: Konrad Stadelmann

“The earth still hasn’t quietened down,” according to Stadelmann. The people in Sibratsgfäll have learned to live with the forces of nature, building houses which can move, which can slide along with the earth. In line with the mentality typical in Vorarlberg, the inhabitants have turned the disaster into something new, something positive. In conjunction with the association “Bewegte Natur Sibratsgfäll” the village has come to terms with the incidents and created the Georunde Rindberg project. This walk is a reminder of what happened, and raises awareness amongst locals and guests that they are part of nature.

His tips: “The Georunde Rindberg gives you the chance to really feel and get a sense of nature in motion. I would also recommend the path to Schönenbach, which is a natural paradise easy to discover from Sibratsgfäll.”



Konrad Stadelmann talks about his home town in the video – the QR code takes you there.

www.bregenzerwald.at/sibratsgfäll-georunde-rindberg;
www.vorarlberg.travel/hike-schoenenbach





»» We have to respect that nature is stronger than we are, and learn to deal with it in both a creative and an innovative way. «

Konrad Stadelmann, one of the initiators of the Georunde. He is working on a good future for his home town. Here is the cube, a crooked space in a – once again intact – environment, one of the stations on the Georunde Rindberg.



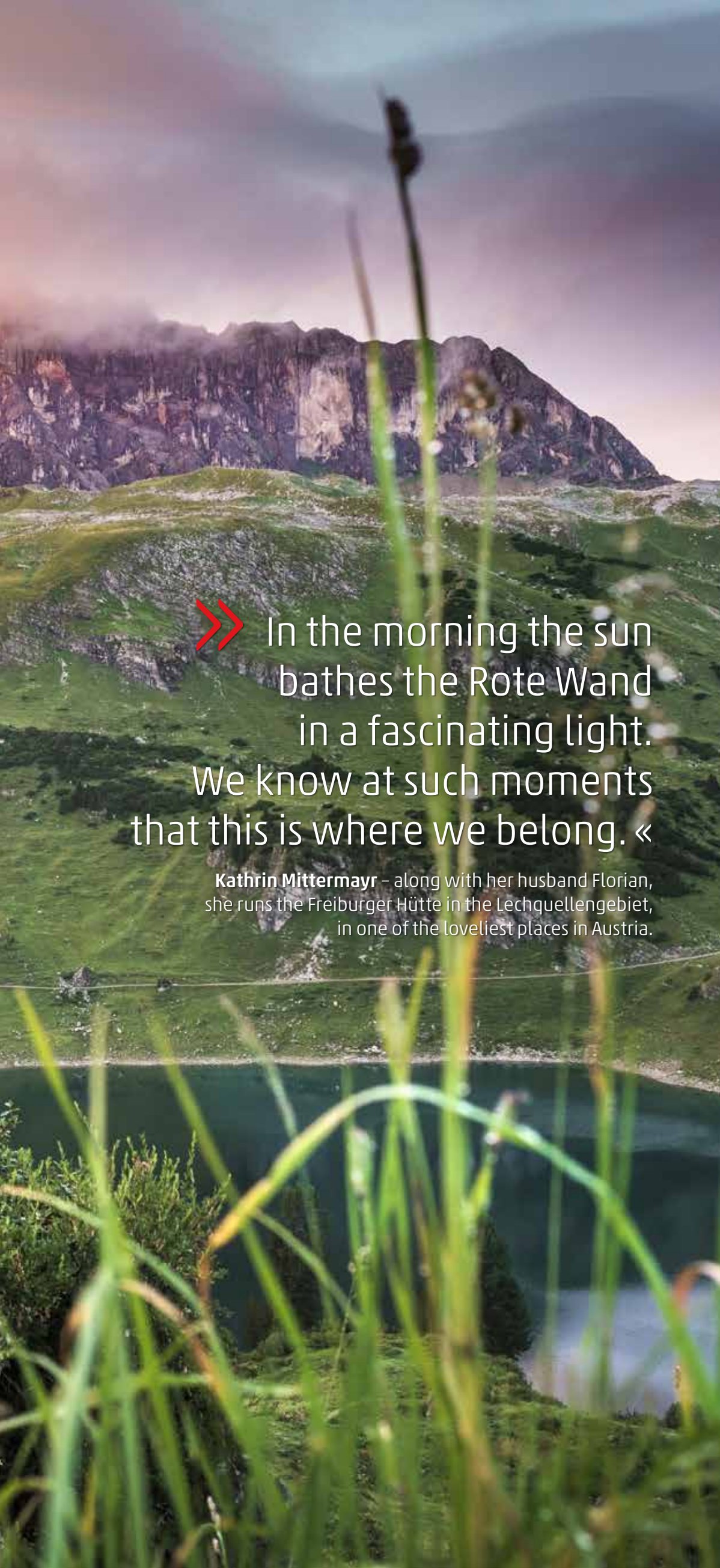

» In the morning the sun bathes the Rote Wand in a fascinating light. We know at such moments that this is where we belong. «

Kathrin Mittermayr – along with her husband Florian, she runs the Freiburger Hütte in the Lechquellengebiet, in one of the loveliest places in Austria.

At their feet, there is the turquoise Formarinsee, opposite an impressive rock formation known as the Rote Wand. Kathrin and Florian Mittermayr work at an altitude of 1,931 metres in the Freiburger Hütte, voted “Austria’s loveliest spot”. This accolade by the Austrian Broadcasting Corporation went to the Formarinsee and the Rote Wand in 2015.

The menu of the Freiburger Hütte includes typical Austrian fare such as bacon dumpling soup, Kässpätzle and cold cuts served on a platter. The couple ensures sustainability and regionally sourced products.



The landlords: Kathi and Florian

Kathi and Florian are passionate athletes in their all-too-short free time: whether cycling, mountain biking and, it goes without saying skiing – the couple spends every free minute enjoying the great outdoors.

The hut is their pride and joy: watching the sun setting on the Rote Wand, they couldn’t imagine life being any better than this.

Their tip: “A trip out to the Steinerne Meer. It takes about an hour and a half, two hours, from our hut. You must be sure-footed, however. The view you get is magnificent.”



The QR code takes you to the video in which Kathi and Florian tell their story.

www.vorarlberg.travel/hike-steinernes-meer;
www.alpenregion-vorarlberg.com



The valleys glitter in a light green, the forests reflect the green of their fir trees, topped by the peaks of the mountains in the light of the morning.

E-biking in the Montafon, you pass pleasant alps, are treated to fantastic views and experience Mother Nature in her summer robes at eye level, such as in the company of Michael Boll. The mountain bike guide has been sharing the beauty of his homeland with guests by bike for a decade.



Right at the top, in the company of Michael Boll

“Incidentally, don’t think that e-biking is only for the lazy,” explains the cycling pro. “It is definitely a sport. After all, the e-motors only produce energy when you pedal.”

Michl, as he is known around these parts, frequently takes groups of cyclists on the “sun balcony tour”, which takes them across Bartholomäberg and the Silbertal. You can cover part of this tour by taking the Kristberg cable car. This leg is very scenic, he says, emphasising that “you always cycle in the sun.”

His pleasure tip: “Taking this tour by bike, you simply must stop off for a slice of cheese cream gateau in the Panoramagasthof Kristberg. It is to die for!”



The QR code takes you to the video, in which Michael Boll tells his story.

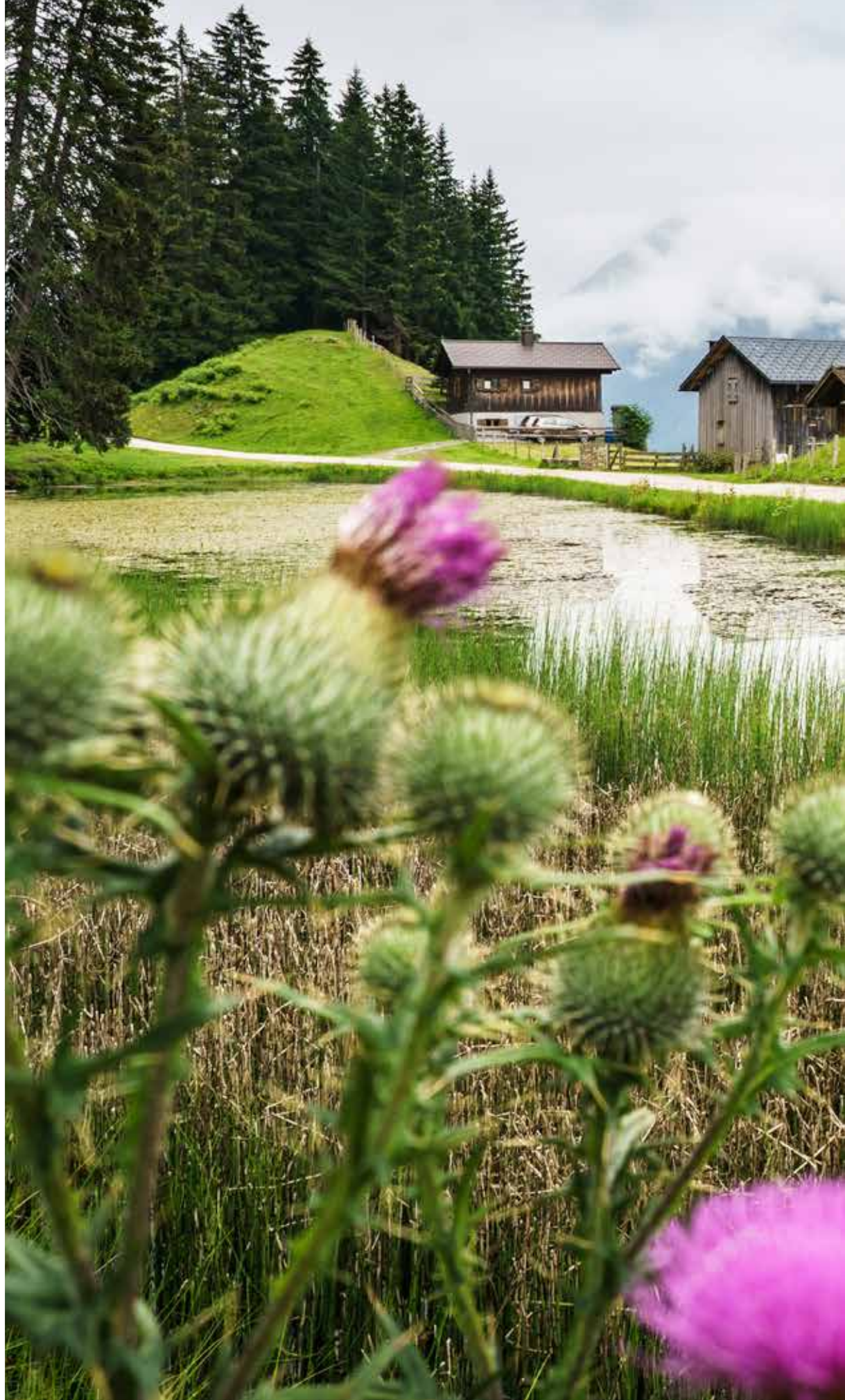

»» The sun balcony tour is scenic – and you get to take the cable car for parts of it. «

Michael Boll – against the mountains and meadows of Bartholomäberg. The mountain bike guide shares with guests the cycling paths in his homeland – frequently his groups travel by e-bike.



“These bridges bridge the gap between natural and cultural landscapes”, says Verena Konrad, Manager of the Vorarlberger Architektur Institut (vai) in Dornbirn. It is the objective of vai, which comprises around 400 members, predominantly from the region, yet also from other places around the world, to promote regional architecture of a high quality, to present it as an interface between culture, art, craftsmanship, industry, science, politics and tourism.



Verena Konrad from vai

Stefan Marte, Chairman of the vai, and Bernhard Marte from marte. marte architekten are responsible for the bridges in the Ebnit Valley which Verena Konrad is presenting as brilliant achievements from both a technical and an architectural point of view. “They are practically poetic designs whose structural realisation will be delighting us for years to come with their simple elegance,” says Verena Konrad. “These bridges also have a social aspect. As the client, the town of Dornbirn has made the settlements in the high valley permanently accessible.”

Her cultural tip: “For me, the most aesthetically valuable places in our region include Allmeinde Commongrounds in Lech am Arlberg, an intellectual retreat that takes on the role of an exhibition designed and run by Katia and Gerold Schneider. I am also a regular visitor to the Kunsthaus Bregenz and the Werkraumhaus of the Werkraum Bregenzerwald in Andelsbuch.”



The QR code takes you to the video in which Verena Konrad tells her story.

www.v-a-i.at; www.allmeinde.org;
www.werkraum.at;
www.kunsthaus-bregenz.at

» They are practically poetic designs which will be delighting us for years to come. «

Verena Konrad – Manager of the vai Vorarlberger Architektur Institut on the structures in the Ebnit Valley in Dornbirn, pictured here with the Schanerlochbrücke.









» I have been coming up here for 27 years now and can never get enough of the beautiful countryside. «

Wolfgang Ott, pictured here with young cowherd Magnus.

The two of them look after the cattle on the Bärgant high alp in the Kleinwalsertal during the summer months.

Magnus Huber is 12 years old. Like all kids, he loves the summer holidays.

This is when he heads off up the mountains. Magnus then spends a few weeks in the role of a young cowherd on the Bärgant high alp, at an altitude of almost 2,000 metres. In good company: another couple of lads, experienced cowherd Wolfgang Ott and 240 young cattle, 12 horses and two cows.



Wolfgang and Magnus with one of their heads of cattle

Life on the alp is very simple, without a television or the Internet, but Magnus doesn't appear to be missing anything. He is already a good help, checking fences, doing the milking, clearing the perennial plants in order to make way for grazing areas, and looking after sick animals. All this is in a day's work. So what does he want to do when he grows up? "Maybe I'll be a cowherd," he says. "We'll see."

Their tip: "If you have already made it this far, you really should push on and conquer the rest of the trail as far as the top of the Widderstein. It is impossible to describe the view from up there."



In the video, Magnus talks about his life on the alp – the QR code takes you there.

www.kleinwalsertal.com
www.vorarlberg.travel/circular-hike-widderstein

Enjoying nature with all the senses

The best of the mountains and Lake Constance comes together here – dine your way from alp to alp, take a stylish trip across the water or sample mountain cheese and fine honey. Vorarlberg offers inspiring experiences with nature for all tastes. The best way to discover the state is by e-bike or on foot.



Maturing process on the alp

The milk from the mountains and a maturing time of many months are what give it the right taste: tasty mountain cheese is an essential Vorarlberg speciality, some of which is produced directly on the alp during the summer months. In addition to mountain cheese and alpine cheese, the state boasts cream cheese specialities, and goat's cheese and sheep's cheese delicacies. Typical for the Montafon is Sura Kees, a mild, aromatic low-fat cheese.

A substantial 60% of all the milk produced in Vorarlberg is turned into cheese, which has an important culinary role to play throughout the whole of the state: it is served up in restaurants and huts as the most important ingredient in "Kässpätzle". Lessons where you are taught to make your own cheese are available. Naturally, the cheese can also be ordered online, getting you in the mood for your next trip to Vorarlberg.

www.vorarlberg.travel/cuisine

The steamboat to beat all steamboats

There is no more stylish way to greet the sunset on Lake Constance: the lavishly renovated paddle steamer Hohentwiel offers gourmet trips, amongst other services. Chef Heino Huber is proud to present a five-course meal on board. The time-honoured boat also offers the following services: a Captain's dinner, jazz brunch, trips to the Bregenz Festival and an English afternoon tea of sandwiches and muffins. The paddle steamer's home harbour is in Hard, close to Bregenz, and this is where the gourmet trip starts and ends.

www.hohentwiel.at





»» The whole of nature is a melody which conceals a deep harmony. «
Johann Wolfgang von Goethe

Biosphere Park Großes Walsertal

Experience intact nature

“Use nature without doing it any damage” is the philosophy pursued in the UNESCO Biosphere Park Großes Walsertal. This unique mountain valley lies off the beaten track, away from the major traffic routes, yet in the centre of Vorarlberg. Guests can experience an intact, almost unspoilt mountain landscape, and meet warm-hearted people. As a biosphere reserve, the Große Walsertal is a model region enabling various options pertaining to the preservation of the diversity of nature and the sustainable development of the valley to be tried out. Currently, 230 kilometres of marked hiking paths, 40 summits and 47 farmed alps invite you to take a ramble or a hike. **There are many interesting ideas for outings in the region’s countryside on offer, three of which we are presenting here:**

1 The summer culinary trip is a particularly enjoyable offer: it is a hike whereby a four-course meal is served in four different locations. For around four hours, starting from the mountain

station of the Sonntag-Stein cable cars, you hike to several different alps to enjoy the various courses.

2 The biosphärenpark.haus in Sonntag-Stein is definitely worth a visit: the architecturally pleasing mountain wood building houses an exhibition about the valley, an adventure alpine dairy, a restaurant and a shop selling products from the biosphere park.

3 In the Lutz sulphur bath in Sonntag-Buchboden, managed by the Wassertal association, you can relax in the warm sulphur water surrounded by nature itself. The water from a sulphur spring in the bottom of the valley is heated by wood. Following the bath, the guests rest on a small platform and take in the view of the mountains.

 www.grosseswalsertal.at;
www.walsertal.at



High up and on the edge

You get brilliant views across the Rhine Valley and Lake Constance from the "Karren-Kante": the 12-metre long footbridge is a viewing platform on the Karren, Dornbirn's local mountain. Art installations accompany the "Auf Sehhöhe" arts trail which is around a 30-minute journey from the mountain station of the Karren cable car.

www.bodensee-vorarlberg.com/karren-seilbahn

Land of milk and honey

Not only do bees provide valuable honey – they also make sure that an abundance of fruit grows on our fruit trees by pollinating their flowers. Going along on a Montafon bee ramble from the baroque church in Bartholomäberg to Schruns allows you to find out a great deal more about the busy insects. Beekeeper Harry Trautmann is the guide, who takes you past several beehives on the way. Harry is a good storyteller – telling you about his job, about honey and the valuable properties of the bee glue propolis.

www.montafon.at

Culinary tour to an organic farm

A weekly offering in the Kleinwalsertal is a trip to an organic farm by e-bike. The guided culinary tour takes 2.5 hours in total, including a sampling session on the Stephanie holiday farm. There, farmer Bernhard Fritz explains why regionality and organic food are a passion of his.

www.kleinwalsertal.com



Preserving and experiencing nature

"Nature doesn't do anything in vain", the Greek philosopher Aristoteles once said. It is worth taking a good look and preserving its treasures. And that is why the "Naturvielfalt" initiative was born in Vorarlberg: in it, the two nature conservation associations Rheindelta and Verwall, the Biosphere Park Großes Walsertal, the inatura Erlebnis Naturschau and Nagelfluhkette nature park jointly develop strategies for the integrative and regionally rooted preservation of nature.

All regional stakeholders are convinced that natural diversity is the basis for a good life. There are 39 Natura-2000 areas in Vorarlberg – proving that the state is doing a lot for the protection of the environment and nature conservation. As a guest, how can you discover the environment and nature in a careful yet enjoyable and adventurous manner? Nature guides trained especially for this purpose offer tours through the protected natural spaces and allow interested parties to view the abundance of species as well as rare plants and animals.

www.inatura.at



SIMPLY MULTISPORT.

Active lifestyle meets pristine nature

If you dare to venture off the beaten path you will find a spectacular panorama in the middle of the Alps. Within minutes you can escape the hustle and bustle of your busy life. Recharge your batteries while sitting by a crystal clear lake or summit the nearby peaks. However you choose to explore the splendid Vorarlberg nature, skinfit® would like to accompany you. Our products were born in the local mountains. Their uncompromising functionality and versatility make them your ideal companion while enjoying the great outdoors.

Skinfit is a local sports clothing company headquartered in Koblach (AT), specialized in high-end apparel for endurance and outdoor sports. skinfit® enhances the active lifestyle of outdoor enthusiasts by delivering innovative sports apparel of superior quality, functionality, and design.

Visit our local Skinfit Shops in Koblach, Dornbirn, Nenzing, and Egg or purchase online.

www.skinfit.eu





Meadow motley

The Steurer family moves up to the Streichbrunnen alp, close to Hittisau in the Bregenzerwald, during the summer months. They move up there because of the peace and quiet, the view, nature – and because of their animals. The steep slopes on the alp are only hand-mown once a year, enabling a veritable plant paradise to thrive. A visit to the Meadow Champions.

TEXT: THOMAS ZWICKER PHOTOS: DIETMAR DENGER



No reason to complain:

the animals are well treated by the family. Veronika Steurer loves her goats.

Lasting beauty:

the meadows here are still mown by hand. The alp is paradise on earth for a multitude of plants.

The narrow road meanders steeply up the mountain from Hittisau, a village of almost 2,000 inhabitants boasting a fantastic location in the Bregenzerwald. The road goes through alpine meadows, green forests, again and again revealing massive panoramic views to the side.

Then, at a lofty height, a small roadway turns off to the right; two paved tracks feature only high grass between them which swooshes on the spoiler of the car like the rough sea on the bow of a ship. The path comes to an end at a large farm located in the middle of flowering meadows. One half of the farm, adorned with green shutters and window boxes, serves as living quarters for the family, and the other half as a barn for the happy livestock. Veronika and Vinzenz Steurer live on the Streichbrunnen alp with their son Patrik during the summer months. They are mountain farmers. Not only

that – they are also Vorarlberg Meadow Champions. It is very quiet up here, the only sound the ringing of the goats' bells. "Depending on the weather, every year around about May we take everything but the kitchen sink and our animals from our farm here in the valley and move up to the alp, lock, stock and barrel," says Vinzenz Steurer, crotchety and gruff as he is, yet with a warm-heartedness that immediately takes hold of you. "In September, we pull down the shutters and we go back down into the valley – that is the end of our summer on the alp."

The secrets of biodiversity

During the bright half of the year, the Steurers manage their Streichbrunnen alp, located at an altitude in excess of 1,000 metres above sea level, around 22 hectares in size and already being run by the fourth generation

Well looked-after: the mountain farmers' house, where man and beast live together under one roof

» We were delighted to win the prize since we put all our life's blood into our work. «

Veronika Steurer

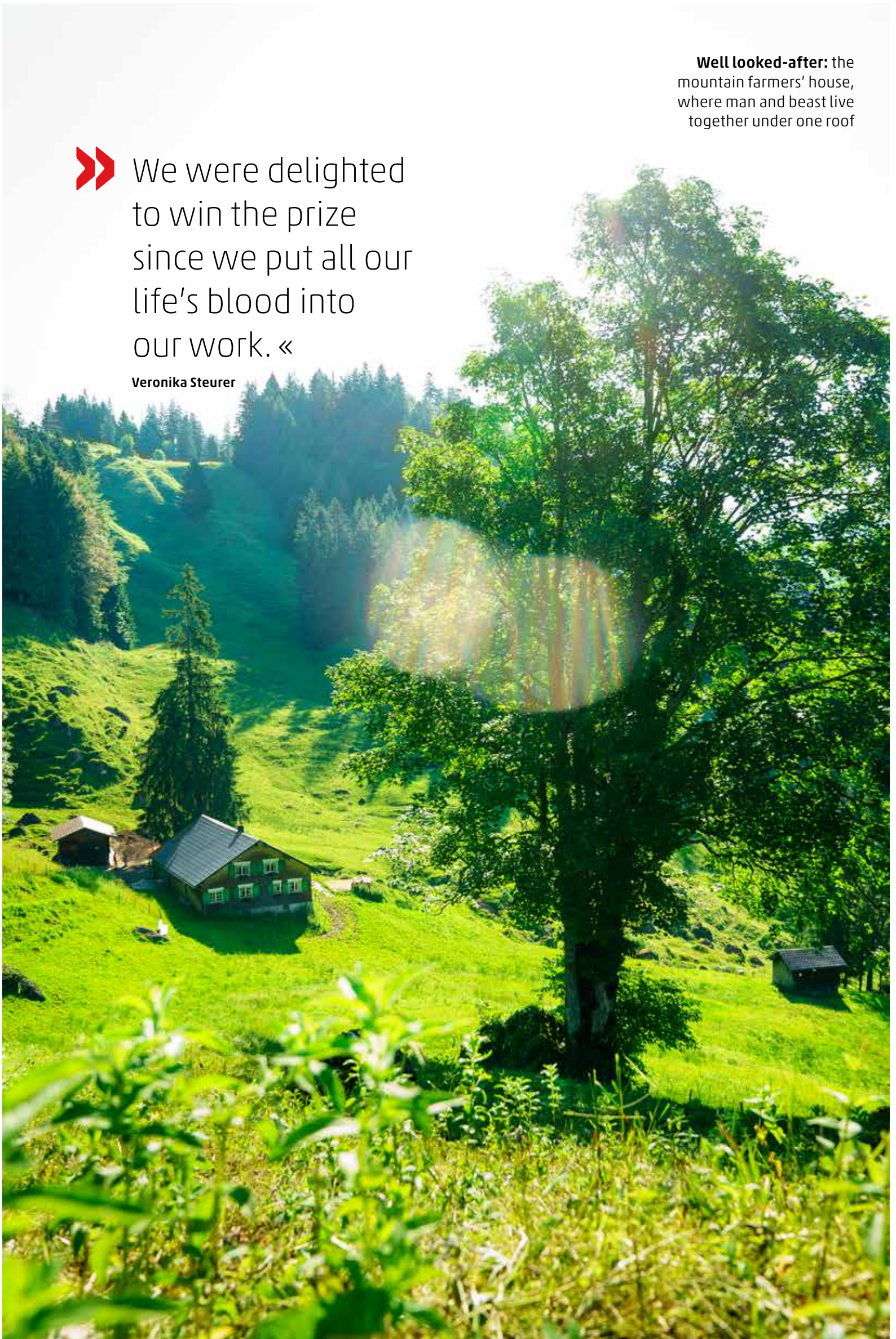

What is the Meadow Championship?



The state government of Vorarlberg, in cooperation with the Vorarlberg nature conservation council, have been organising the Meadow Championship since 2002. The UMG environmental office is responsible for evaluating the meadows. Farms practicing minimum ecological standards are eligible to enter. The competition praises all those who stand by their responsibility for the habitat of our state.

There are three prize categories: individual space, overall farm and alp farm. In the category alp farm, the aspects of incidence of rare species of plants, balance of the population of species in the meadow, landscape elements, trampling damage, fertilisation using manure yes or no, meadow care and biotope protection are judged.

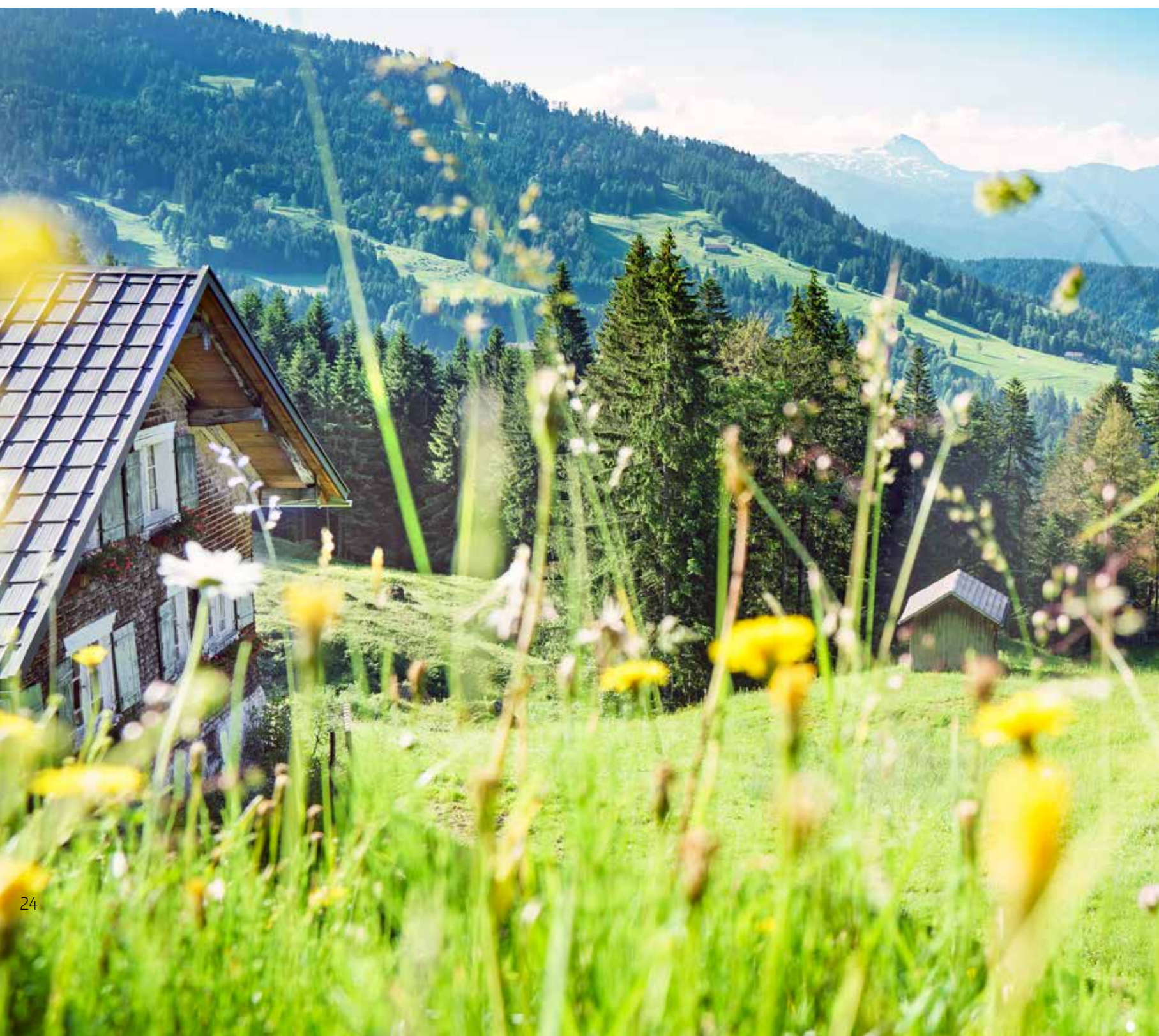

of the family. It is with a great deal of tender loving care and in a sustainable manner according to traditional methods that they farm the alp. And the family are so successful in this endeavour that, last year, they were awarded the title of Vorarlberg Meadow Champion at their first attempt.

“This is the evening primrose,” says Veronika Steurer, “if it closes at midday despite the sun shining, that means that the weather is about to change and it is going to rain.” The cheerful, ruddy-cheeked mountain farmer points at a daisy (“they are good for bile”), next to which marguerites, wild lilies and greater yellow rattles grow. Chives are used in food, mint and wild marjoram are used to make tea. This meadow is also home to several inedible herbs which even the cows give a wide berth to.

“We wish to preserve the beauty of nature, our plants,” says Veronika. “That is why we only mow by hand once a year that which our animals don’t eat and merely weeds. Everything else is left to its own devices.” It is thanks to this time-intensive method that a colourful sea of flowers blossoms and shines on the meadows of the Streichbrunnen alp, flowers going back centuries continue to thrive here – and this delighted the jurors of the Meadow Championship Vorarlberg. The objective of this competition, held by the state of Vorarlberg, is to reward the energy and time expended by farmers such as the Steurer family in the preservation of the centuries-old use of the areas of unspoilt nature, ensuring the continuing beauty of the Vorarlberg countryside, also creating the basis for its immense relaxation value. One of the criterion considered in the Meadow Championship is the incidence of rare plants

Saying it with flowers: even from up here, the horizon is quite some distance



»» We pull down the shutters in September. That is the sign that our summer on the alp is over. «

Vinzenz Steurer

Journey to the valley:
the milk from the animals is transported down to the valley by means of an old cable car



on the estate of the pertinent applicant, as well as other endeavours towards farming the meadows in line with the location (see box).

How do you become a Meadow Champion?

The Steurers first entered the championship in 2015 – hikers constantly stopped by to comment on the beauty of their steep meadow slopes, yet it was with a feeling of trepidation that they submitted their application. “The jurors spent hours in the ferocious heat of July out and about in the meadows, digging up roots and explaining to us what they could be useful for,” says Veronika. “It was only then that we really became aware of the massive diversity we have up here, and we were delighted to win the prize since we put all our life’s blood into our work.”

This also includes affectionate animal husbandry. Around 35 cows, bulls, calves and goats live along with

the mountain farmers on the Streichbrunnen alp. It is only at night that they are in the barn – during the day they are free to graze on the fresh mountain herbs. The milk is transported to the valley via cable car – it would be too troublesome to send it to the valley via the narrow, bumpy road over the long term. Veterinary surgeon Daniela Erlenbusch from Hittisau has just popped by. The vet is responsible for many of the farms in this area.

Life in the mountains is simple – there is no electricity or running water

The mountain farmers have to do without many a modern comfort during the summer. There is no water pipe up here, no electricity. The Steurers cook on the wood-burning stove, and get fresh water from mountain springs. One of these springs flows into a small concrete basis in the room next to the kitchen: the food keeps nice and cool in the cold water. “We cannot make ice cubes, that’s all,” regrets son Patrik. At least a small, open four-wheel drive diesel van with



Life on the alp: the vet does her rounds. A play of colours with flowers and butterfly.

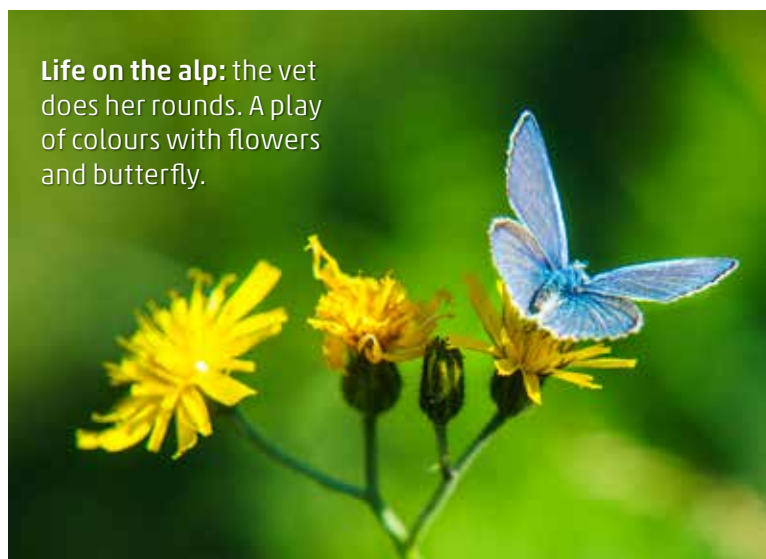



Mother Nature's wealth: the small treasures on the meadows bagged the big prize



Veronika and Vinzenz Steurer on video



Scan the QR code to experience the mountain farmers with their animals on the Streichbrunnen alp.

More on the topic also available at:

 www.bregenzerwald.at



a whopping 25 HP helps them to farm the steep slopes of the meadows. “It will soon be 50 years old, but it still gets you out and about reliably,” says Patrik.

Doors are left unlocked on the alp

So what else is life like on the Streichbrunnen alp, in the creaky wooden house with the gorgeous flowers outside the window, protected by a 200-year-old spruce, affording a view across the lovely valley as far as the Widderstein (2,553 metres), Diedamskopf (2,090 metres) and the Hoher Ifen (2,230 metres)? “You don’t have to go around locking the doors up here, it’s safe,” according to farmer Vinzenz. “I will gladly take things over later, I love the countryside up here, it’s beautiful,” says his son.

Mother Veronika proudly points at the Meadow Champion certificate – confirmation that things are going pretty well here, up on her mountain. “We have the view, the tranquillity, nature,” she says, adding, “we don’t know anything else but moving up here year after year.”

A good deed for body and mind

Hiking is the best medicine

It has long since been known that exercise in the great outdoors is healthy. Yet, why does hiking make us happy? Prof. Reinhard Haller, psychiatrist, has some thrilling, scientifically proven answers.

Whereas the positive effects of hiking on physical health have been well researched, far too little is still known about its effect on the psyche. Like all endurance sports, hiking boosts our physical fitness and leads to a general increase in performance. It improves the metabolism, strengthens the immune and hormone systems, promotes muscle strength and endurance, prevents osteoporosis and atony of the skin, stimulates formation of the blood and is the best means for achieving weight reduction. A medicine that could contain all the effects of hiking regularly would be the epitome of the magic bullet and the best-selling pharmacological drug ever. Hiking also has a positive effect on health in general by improving sleep, promoting a sense of well-being and having relaxing properties. However, particularly impressive are the effects on the psyche and mental well-being which are far too often ignored.

Psychogeographics has proven how much landscapes can leave their mark on the nature of a person and determine their emotionality. Many landscapes are familiar to us, others make us feel sad and melancholy, still others give us a feeling of security and inner peace, or even of longing and a feeling of awakening.

Moreover, hiking accommodates today's widely-held need for a life in harmony with nature, for a reduction to the essential and individual freedom by means of simple needs. The slow-travel movement has not only discovered the feeling of slowness, it has also turned the journey into the destination itself. Hiking results in the psychological intensification of all the senses, to the mental consolidation of thoughts and emotions. To paraphrase the passionate hiker Johann Wolfgang von Goethe: "You have only really been there if you walked there."



A pill that contains all the effects of hiking regularly? It would be the epitome of the magic bullet – a bestseller. «



» Hiking encourages creativity, and reduces frustration.«

The effects of hiking on the biology of the brain are scientifically proven, affecting the central reward system in particular. The constant physical exertion activates several areas of the brain which communicate via the chemical messenger dopamine in a similar fashion to how this can be achieved by hypnosis, autogenic training and meditation techniques. The brainwave activity is regulated in a similar way by hiking and these therapeutic relaxation methods.

A precise psychological analysis demonstrates that hiking largely fulfils the main objectives of psychotherapy, which are connection with nature, orientation in the internal and external landscape, the attainment of pleasure you get from a runner's high and high-altitude euphoria, the avoidance of un-pleasure triggered by angst and depression, the increased sense of self-worth you get from a sense of achievement, the distancing from daily worries, the development of new perspectives and, ultimately, the attainment of a sense of tranquillity. What is better for our sense of self-worth than conquering a mountain peak, what bestows us with a greater sense of tranquillity than observing a far-off toy world from a scenic loftiness? Hiking helps us to distance ourselves from our daily problems, and puts our cares and worries into perspective. We can wend our way to new worlds, including those inside us.

Hiking incorporates various psychotherapeutic techniques and therapy methods which we would otherwise have to pay for, at least to a certain degree: hiking is an excellent physical therapy. Drug addicts who frequently suffer from the feeling of alienation from themselves ("my body doesn't belong to me") suddenly reconnect with themselves: in the beating of their heart, in the blowing of their lungs, in the tensing of their muscles. Hiking is inevitably associated with the conscious breathing-in of air, meaning it has a similar effect to a breathing therapy. Hiking results in slowing down, in an awareness for the here and now, in letting go.

Since hiking through the open countryside and across the mountains is also a hike to your inner self, it offers a good setting for an internal discourse, a psychotherapeutic technique whereby the subject talks about a problem in an exchange with themselves. By converting our emotions into physical energy, hiking reduces the level of frustration, and presents a first-class anti-aggression therapy. Like all endurance sports, hiking is a natural remedy for all forms of depression. Every 30 minutes' constant exertion increases the levels of the chemical messengers serotonin and noradrenaline, which are reduced in people with depression. At the

same time, endurance sport results in natural euphoria. Recent scientific examinations have proven that three hiking sessions per week have a similar effect to that achieved by high-potency psycho-pharmaceuticals amongst people with depression. Conclusion: hiking is also one of the most effective prevention and therapy options for burnout. Incidentally, the great Danish philosopher Søren Kierkegaard, who himself suffered from depression, also came to this conclusion, summing it up in writing thus: "My best thoughts came to me walking, and I know of no problem that cannot be walked off." A study performed at the University of Salzburg has proven that hiking strikingly improves the prognosis in suicidal patients.

Also scientifically proven is that hiking stimulates our creativity. Simply encountering new landscapes, breathing freely in the open countryside and inspiring our imagination by means of the beauty of Mother Nature imparts us with a plethora of new ideas, and opens up previously unknown dimensions of feelings. This would make hiking into one of the most effective psycho-pharmaceuticals if we could compress all of its effects into one tablet. Which would be a shame, since hiking, especially in the mountains, is far too beautiful to experience to reduce it to a chemical substance.

None of these explanations are the sheer romanticising of opinions or make false claims regarding curative effects. The experience of nature and hiking cannot perform miracles, yet have a great deal of psychotherapeutic functions. I am not saying this after my many years' experience as a psychiatrist and psychotherapist because I have so little respect for psychotherapy but because I have so much respect for hiking – specifically in the mountains.

Biography

Prof. Reinhard Haller, born in Mellau in the Bregenzerwald in 1951, is one of the most renowned psychiatrists, psychotherapists and neurologists in Austria.

Research into addiction is the main focus of his work. Reinhard Haller has also gained renown as a court-appointed psychiatric expert.





Stream in a bed of rock: the Silbertal branches off to the east close to Schruns and is seen as one of the most authentic valleys in Vorarlberg



It flows. It foams.

It is a shame that we spend so little time contemplating the importance of water for our life. It is different in the Montafon: here, in the mountains around the Silvretta, you get a direct sense of its force and its beauty.

TEXT: STEFAN NINK PHOTOS: DIETMAR DENGER

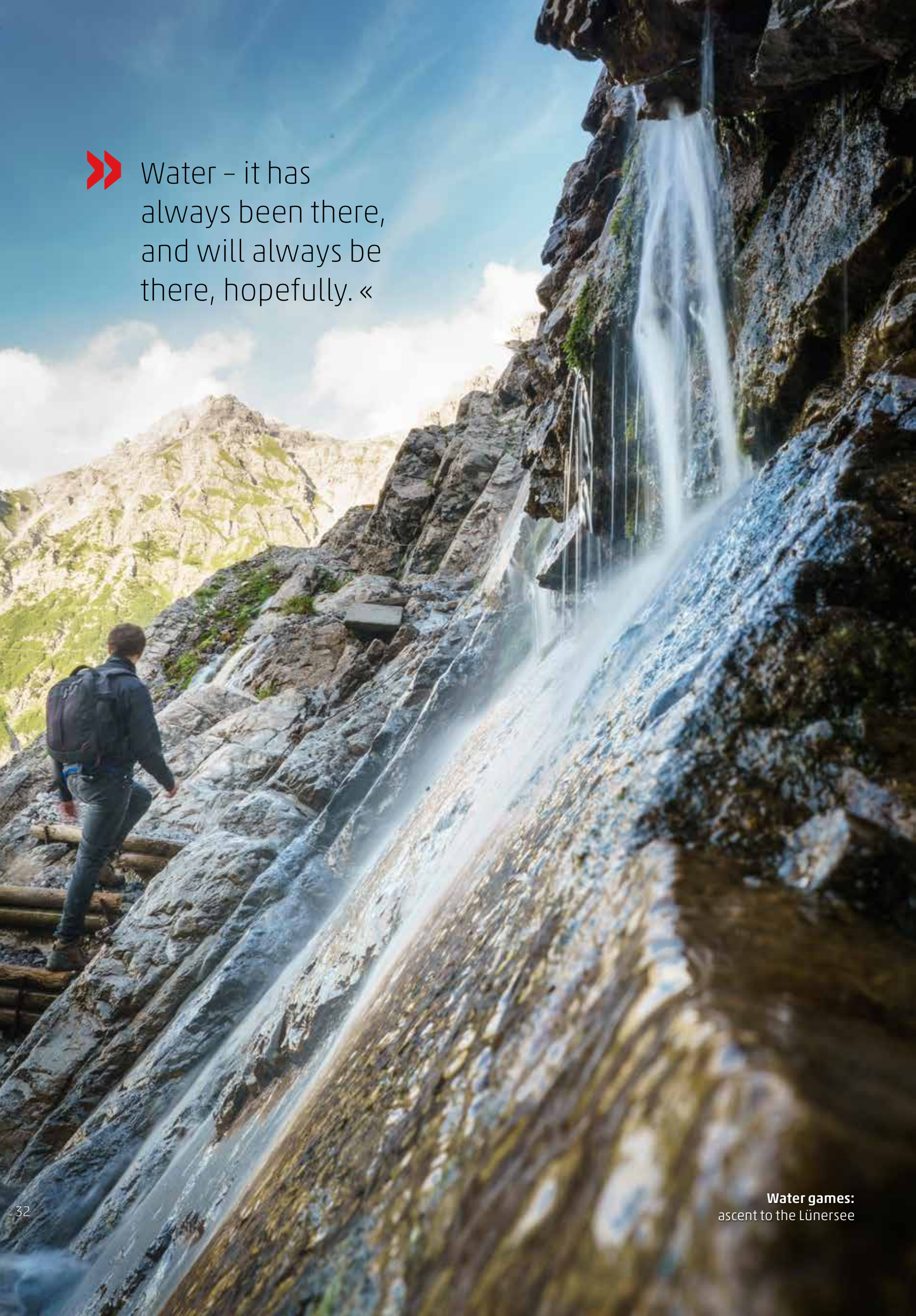

» Water – it has always been there, and will always be there, hopefully. «



Reflection of the mountains: the Lünensee at an altitude of 1,970 metres

Sometimes it goes like this: it is very early in the morning, on a hiking path in the Montafon, the valley already some way behind you, the summit still some distance away, and suddenly you feel a drop on your face, followed by another one, and since the weather forecast had predicted good weather and it wasn't supposed to rain, you put your head back and see – a blue sky.

A couple of light-grey clouds are hanging on in there – maybe they are responsible for the couple of splashes. And over there, on the side of the mountain, there is something shiny. Morning dew, you think, and are amazed that you can actually see it. A bit further up, the sun lights up rivulets – thin, silver veins on grey rock, and above it a field of snow glitters like a mirror. You are standing there on a trail and, for a brief moment, there is something in the air that you could call understanding or even realisation, but before things start getting too philosophical you simply continue on your way. You don't even realise that the roaring in the background doesn't actually come from

the road below. Instead, it comes from the waterfall on the other side of the valley.

**Water can shout at you.
Yet it can also produce quiet,
almost tender tones.**

To be honest, we spend far too little time thinking about water. Especially not when on holiday, although there are no more suitable places than the mountains for doing so. And probably no better place than the Montafon. The valley of the Ill is edged by mountain ranges towering into the sky, the Rätikon with its lime pinnacles, on the other valley side the Verwall, all mountains, none of them exactly small and, at the end of the valley, there is the Silvretta with its mountains over 3,000 metres high. You cannot exactly claim that the geology in the Montafon has been restrained in any way – naturally, such a landscape has the best possible conditions for water, if it's possible to say that. Water has one main property: it always wants to flow downwards! When allowed to do so, it displays its beauty. And its force. As well as its power.



Dramatic sun and clouds: a view of the Silvretta alpine road

Obervermuntwerk II



Vorarlberger Illwerke AG is the biggest energy supplier in the region. It generates its electricity exclusively from hydropower and other renewable sources of energy. In total, the company has ten power stations, four reservoirs and several basins.

Vorarlberg is a pioneer in the field of alternative energy and clean electricity. "Obervermuntwerk II", the new pumped-storage hydropower station (photo of the construction site) is set to start operating in 2018. The "Energieraum" in Partenen enables interested parties to have the hydropower plant explained to them by means of multimedia. Put very simply, it will work like a huge storage battery: when required, it provides energy. In the event of over-capacity, the water can be pumped back into the reservoir, which is located 300 metres higher up.

So let's start from the top, on the Silvretta, where the water spends many months of the year as snow and ice. The two milky blue reservoirs of Silvretta and Vermunt provide people with electricity produced from hydropower. All the lorries and containers are here because, between the two lakes, deep inside the mountains, a new hydropower station is being built – the monumental Obervermuntwerk II (see box). For his part, Hansjörg Schwarz is walking around here looking at things since he and the team from the Illwerke are responsible for making sure that no trace of the construction work will be visible once all the excavators and pipes and construction site paraphernalia have disappeared. Ecological construction supervision, as it is known. All the excavation hills from the inside of the mountain, for example, will be planted with perennials and rough grasslands that hikers will consider totally normal hills within three or four years. "The massive project must not be allowed to endanger the scenic beauty of the region," says Schwarz, "so it's great if we can correct even the little



Continuous roaring: wooden bridge over the Teufelsbach waterfall in the Silvbertal



The power of water: engineer Hansjörg Schwarz on the dam of the Silvretta reservoir

things in advance.” Anyone who sets out to tame water bears a special responsibility. For nature. “And for people who will want to live in the Montafon after us.”

Naturally, only a part of this water is being tamed up here on the Silvretta, and naturally the rest of it wants to flow down into the valley, impetuously and wild, and over paths it has searched for or created for itself over the course of time. In order to get a feeling for what this is like, you just have to hike to the Silvbertal after a rainy day. This takes you from Schruns to the east and is considered one of the most original of the valleys in Vorarlberg. There are three or four alps behind Silvbertal as well as a handful of weekend houses and then – nothing. No roads, no villages. Just nature. Just steep slopes to the right and to the left and the vast sky above it all, and the snow-covered spiky peaks of Omesspitze and Lobspitze somewhere on the horizon. It is full of families on good weather days. On rainy days it is one thing above all – impressive. Everywhere – simply everywhere – there is water, it flows in strings

from the slopes, it splashes downwards in streams, it thunders in waterfalls, it foams and roars and crashes and bangs. On days like this in the Silvbertal, there are minutes where you have to shout to be heard, the water is that loud. As well as moments you would like to whisper so that you don't disturb the tender passages of the water symphony around you. And if you pay attention, you feel at every breath how the clear, cool air seems to flow right down as far as the finest branchings of the lung.

The people here live with the water, and know how tame it

“Try it! You have to try it too!” This now comes from Ewald Netzer who is holding his cupped hand out underneath one of the many rivulets. “The water tastes different from every source here!” Netzer was born and bred in this region, and quite possibly there is nobody who knows more about the local water, the springs and its healing power. The Warzenbächle is



Crystal clear, cool: Edwald Netzer at a fountain in the Silbertal. The dog tries to cross from the Tafamunt alp to the Wiegensee without getting its paws wet.

one such example – people would go to this stream (“wart stream”) to wash their hands, and two weeks later their warts would be gone, he explains. True! Apparently, this is due to the high silver content in the water. “Or maybe due to the faith they have in it. Whatever, gone is gone.” There was once a health spa in the Silbertal which people used to attend to cure their symptoms as far back as in the 17th century. “And the people from the valley still use the springs.” The snow that spends the winter at high altitude melts between the spring and the autumn, before the world

turns back to white. It is a continuous backwards and forwards, up and down, that has been announcing the coming and going of the seasons and the flow of time for thousands of years. The people in the Montafon live with the water, and they have always known how to tame it. It is by applying the art of engineering and great stamina that they have constructed reservoirs and built hydropower stations: they have used the water to operate their sawmills and treated their warts with. They route it to swimming pools and bathing lakes, and local artists such as composer Herbert Willi use it as their source of inspiration for symphonies.

An ocean once foamed in the Montafon. The coral reef has become fossilised.

Culture, history and tourism in the Montafon are closely associated with the changeable water, as is its geography. It has always been there, and it will always be there. Hopefully. All you have to do is take a walk in Bartholomäberg to get an idea of how long the Montafon has been associated with water. Follow the geology trail up as far as the Obere Wiese. Between the grass and the flowers, you will find a fossilised coral reef with fossilised shells, sea lilies and, naturally, coral stocks. Once upon a time, an ocean used to froth and foam here. Until the earth decided there was something missing. And it created the Montafon, with its mountains and peaks towering up heavenwards, and the valleys between them.



Disrupting nature as little as possible



In the video, engineer Hansjörg Schwarz explains his job as an ecological construction supervisor in the construction of the Obervermuntwerk II. The QR code takes you directly to the video.

More about the region:

-  www.silvretta-bielerhoehe.at;
- www.luenersee.at;
- www.vorarlberg.travel/nature-trail-bartholomaeberg



Nature and technology:
great fishing is to be had at the
Lünersee these days. The ascent
can be made from the Montafon
and from the Brandnertal.



It was the tawny owl ...

... and not the nightingale! In the form of the "Shakespeare on the Mountain" project, director Thomas A. Welte has taken theatre up a notch – to the Muttersberg natural arena. A home game where Mother Nature herself is at times responsible for special effects.

TEXT: STEFAN NINK PHOTOS: DARKO TODOROVIC





Natural spectacle:
here, the stage
is only one part of
the scenery

It starts to get dark, and behind the stage this dark wall of clouds grows between the mountains, but this doesn't appear to interest Thomas A. Welte, who just gives it a brief glance before turning his attention back to the stage, where Romeo and Juliet are just getting together. "Don't come over here," he mumbles to himself, talking about the clouds. Then he does turn his head once again to the clouds as if he wants to make sure that the sudden change to the light and the air really is to do with the bad weather front behind the mountain peaks. Taking a closer look at him, you see him smiling contentedly.

"Shakespeare on the Mountain" is now in its third year, and if there is one thing you can say about the productions from the past two years, it is that no two performances were the same. Theatre is a different play every performance anyway, even though the same play is performed as the day before is.

In the Muttersberg mountain arena high above Bludenz, however, Vorarlberg's countryside adds a further dimension: a fiery red sunset one night, the call of a tawny owl from the forest behind the stage, or maybe even the clouds and the wind and the rain – and the way they change things. The performances intentionally don't start until later on in the evening, when the ratio between the twilight and the stage light changes by the minute. It is as if the special effects of Mother Nature are deliberately being used.

A different Shakespeare play every year – plenty material for years to come

Naturally, this is the way Thomas A. Welte planned it. The director was born and bred in Vorarlberg, and he long cherished the idea of staging theatre in the mountains of his homeland. "I always knew that if

Bearing antlers:
Juliet at
a rehearsal



High culture:
by cable car
to the theatre

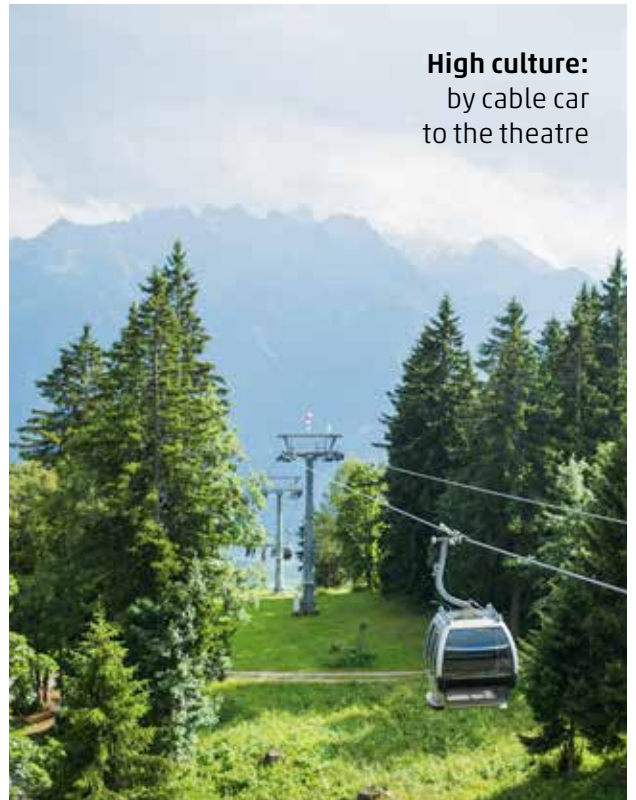

Protection from the rain:
director Thomas A. Welte
in the VIP lounge



» Murder, mayhem, betrayal, loyalty
are still as topical as ever,
never mind love at first sight. «



Magnificent mountains:
down below the
Walgau, up above
Shakespeare

I were to do something like that, I would have to do the plays of an author known to a large audience.” And so he chose Shakespeare, about whom he says: he was someone who made theatre for everyone. Who told stories that touched everyone.

It’s not the contents that make Shakespeare appear complicated these days – murder, mayhem, betrayal, loyalty are all still as topical as ever, never mind love at first sight and against all the odds. “It

is the tricky language of the Elizabethan age that makes Shakespeare so problematic. It often acts as a barrier.”

And so Welte adapts the language of the Shakespeare material and modernises it. It’s a balancing act every time, he says, since he doesn’t want to destroy the beauty of the original. Benjamin Obholzer who, along with Welte, was the inventor of “Shakespeare on the Mountain”, creates additional aids with his stage set: the individual squares of the scaffolding covered in material attract the gaze of the audience.

The audience travel to the theatre by cable car

The theatre company is small, with the ensemble comprising no more than five actors who each play various parts: apart from Michaela Spänle who plays Juliet, they all permanently swop roles and costumes. They do it so skilfully that the crowd doesn’t notice before the final applause that they have only been watching a handful of people for the last two and a half hours. “Shakespeare on the Mountain” is major theatre for the spectators as it is – they are transported up the mountain by cable car and then

»» The audience
can watch the clouds
passing in the sky
and the wind
playing with the
fir trees. «





Love all around?
The drama around Romeo and Juliette, relocated to the mountains

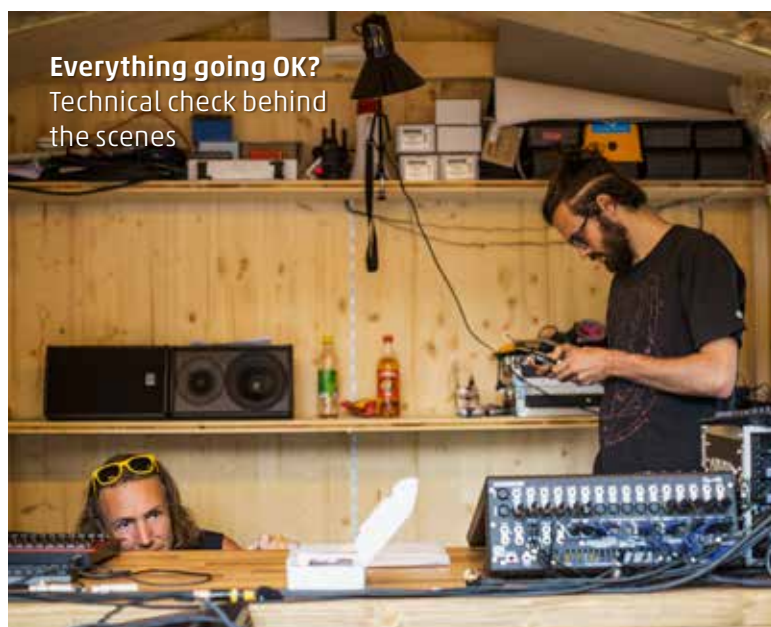

Everything going OK?
Technical check behind the scenes

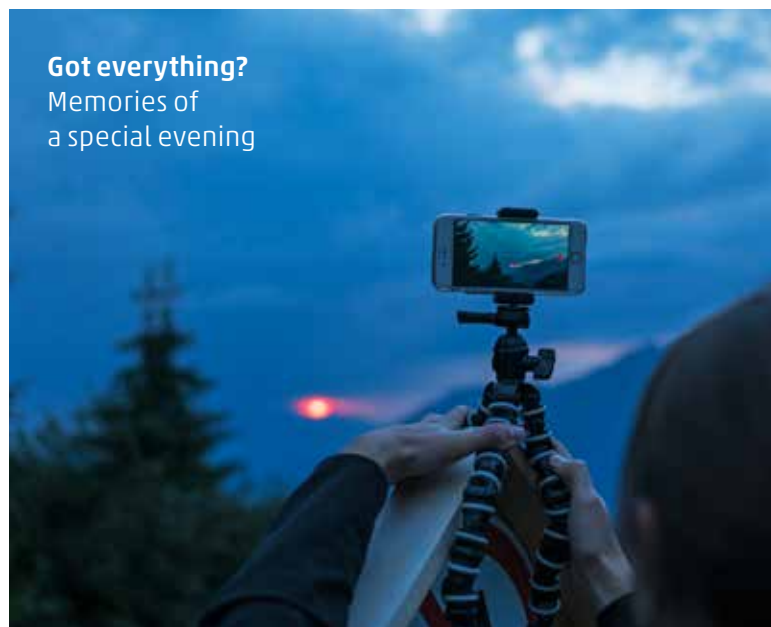

Got everything?
Memories of a special evening

walk for a couple of hundred metres to the open-air stage beneath the Vorarlberg sky. Only the VIP lounges are covered, with the chairs located in steel containers open on the sides. From all the other places, you can see the clouds passing in the sky and the wind playing with the fir trees behind the stage, before the performance starts.

“Shakespeare on the Mountain” was launched with “Macbeth” in 2015, was continued with “Romeo and Juliet” the year after, and “Twelfth Night” is on the programme for 2017. And after that? Then Welte and Obholzer want to plan the next Shakespeare play. After all, the man was somewhat prolific in his writing. Even if they bring a different play to the mountain every year, the material will not run out for over three decades.



The theatre team



In the video, Thomas A. Welte and set designer Benjamin Obholzer talk about their theatre idea.

Simply scan the QR code.



More about the project:

www.alpenregion-vorarlberg.com



Culture stands on its head – or was it a tree?

Nature and culture are never far away from each other in Vorarlberg. They even go hand in hand in many events. Here are our tips for outings to exciting worlds of art.

1

Gauertaler AlpkulTour

Sculptures tell stories, trees grow with their roots facing upwards – and then there is the battle that was never fought: in the Gauertal in the Montafon, the AlpkulTour trail is an entertaining and multimedia tour for discovering the alpine and alpine pasture cultures. The thematic trail artistically designed by Roland Haas provides unusual insights at 13 different stations. Plaques bearing texts in the Montafon dialect explain the backgrounds. Scanning the QR code can call up the High German "translation".

www.golm.at/gauertaler-alkultour



3

LegeArtis Festival, Lech

The international LegeArtis Festival for classical and not-quite classical music has been hosted in Lech for a few years now. It has set itself the goal of attracting young, outstanding artists to the mountains of Vorarlberg.

www.legeartislech.com

2

St. Gerold priory

A small, exquisite events centre with a special atmosphere – that is the St. Gerold priory in the Biosphere Park Großes Walsertal. The sound of concerts can be heard from this venue the whole year round – from jazz and classical through to modern folk music. Courses, seminars and hour-long guided tours of the priory are also on offer.

www.alpenregion-vorarlberg.com

4

Bregenz Festival

Show on the lake: major opera productions are hosted on the lake stage in Lake Constance as part of the Bregenz Festival. In addition to great acoustics and an especial cultural pleasure, the open-air performances always offer impressive, terrific scenery against the backdrop of Lake Constance.

www.bregenzerfestspiele.com





The Werkraumhaus:
One of the stations on the Umgang path in Andelsbuch. Craftsmen in Vorarlberg display their skills here.

5

SilvrettAtelier

Renowned artists from all over the world move their studio to the Silvretta region for two weeks every two years. The works which are created during this period reflect their examination of the place – its nature, tourism or alpinism. Some of the works remain, still others can be seen in exhibitions in the Kunstforum Montafon in Schruns and in the Palais Liechtenstein in Feldkirch.

www.montafon.at/silvrettatelier

7



Kleinwalsertal mountain exhibition

In the form of four stations in the valley and on the mountain, the Kleinwalsertal mountain exhibition informs visitors about the geology and the mountains of the region. Steles in the valley communicate 3-D images of the landscape. For instance, you can find out how the valley has developed since the Stone Age and that Africa and Europe meet here.

www.kleinwalsertal.com

6

Umgang Bregenzerwald

How come the Bregenzerwald looks the way it does? What are the values and ideas behind that which guests experience in the villages and the surrounding countryside? Twelve design paths provide the beholder with insights into the creative enthusiasm of the locals of the Bregenzerwald. On walks taking between one and a half and four hours, you go through any one – or all of – 13 villages. Steel pillars located on each path draw the visitor's attention to a building, to special features of the cultural landscape, to the finesses of a craft or ecological nature, to facets of artistic, culinary or touristic works. Folders providing details are available. Also available is a book on the topic which contains stories about lifestyle in the Bregenzerwald.

www.bregenzerwald.at/umgang-bregenzerwald

8



inatura Erlebnis Naturschau

This exciting museum journey takes you through the mountains, the forest, water and even the human body. The inatura nature Erlebnis Naturschau in Dornbirn is Vorarlberg's interactive, natural history museum. This tour through Vorarlberg's habitats encourages visitors to get hands-on. Moreover, technical and physical phenomena are explained in 40 Science Zones.

www.inatura.at



The mini jungle on Lake Constance

The most biodiverse nature reserve in Vorarlberg is to be found there where the Rhine flows into Lake Constance. The Rhine delta, with its peninsulas, bays and marshlands, is not only a refuge for birds and plants – it is also a uniquely beautiful and exciting wilderness.

TEXT: JOACHIM NEGWER PHOTOS: JOACHIM NEGWER, ACHIM MENDE



» The New Rhine washes up sediments and paints fascinating interplays of colours in Lake Constance. «

Polder dams of the New Rhine – they stop the shore zones from silting up

The sun is low in the sky. It twinkles through a jungle of reeds, meadows and gnarled old willow trees. The Old Rhine flows in its wildly romantic manner through the middle, reflecting all shades of green now in the warm backlight. We walk, following the course of the river, as far as the shore of Lake Constance. The path takes us right through the middle of the Rheinholz, the alluvial forest on the Rheinspitz peninsula. Parking is not allowed right next to the water which means that, even on lovely summer days, these natural pebble beaches next to Lake Constance aren't too busy. "The Rheinholz is my favourite place in the Rhine delta," Ruth Swoboda, the Manager of the inatura Erlebnis Naturschau in Dornbirn, tells us. That is because there are so many breeds of animal and species of plant. And because the moment the forest opens up to reveal the lake is always something special – from the darkness

of the forest to the blazing sunlight sparkling on the water. At least, that is how it is today. Yet even on a rainy day the alluvial forest – which is part of the Rhine delta European nature reserve – is a great day out. The wetness and the mist that sometimes rises make it into an almost mystical place for Ruth Swoboda. Today, she accompanies us through the Rheinholz and explains the nature it holds.

The Rhine delta European nature reserve is the most biodiverse one in Vorarlberg

First of all, let's take a look at the geography – and an oddity. Coming from Switzerland, the Rhine actually flows through Lake Constance. It enters in the south-east, and comes back out in the west, bringing with it around three million cubic metres of suspended matter per year. The milky, colder water of the river is



Break in the shade of a tree:
by bike through
Fußach bay

Ruth Swoboda, the
Manager of the inatura
Erlebnis Naturschau,
on the Old Rhine

visible from well out on Lake Constance. The Rhine delta in the south-east of Lake Constance extends from the Old Rhine on the Swiss border via the Rhine avulsion close to Fußach, the so-called New Rhine, as far as the Dornbirner Ache in Hard. The European nature reserve, the second-largest in Vorarlberg and the most biodiverse, is home to four villages.

“In addition to Fußach and Hard, we have Höchst and Gaißau as well as the state of Vorarlberg as members,” Walter Niederer, Manager of the Naturschutzverein Rheindelta, tells us. The association sees itself as a mediator between the interests of the villages on the one hand and issues pertaining to the nature reserve on the other hand. “The Rhine delta is extremely attractive for cyclists, for walkers and, of course, for bathers,” says Niederer. “However, several areas have to be especially protected at certain times of the year.” This is to help Mother Nature to keep her massive shallow water zones as uniquely biodiverse as they are.

The Rhine is a veritable doer – it keeps on creating new biotopes

Take Fußach bay as an example: many boats anchor here in the summer. Bathing guests enjoy the beautiful nature. Between the months of October and March, however, the region belongs to thousands upon thousands of resting waterfowl. The bay is closed off to people during this time. On the other hand, other places are not accessible during the summer months since this is the breeding season for some of the around 330 species of bird already spotted in the Rhine delta.

“Of course, the high tide of the river makes it dangerous for us humans,” says Walter Niederer. “Yet the Rhine constantly changes the landscape, pours sand onto it, and keeps on creating new biotopes the likes of which no longer exist anywhere else.” It makes the Rhine delta into the wildest region on Lake Constance. In the form of marshlands and two peninsulas, the Rheinspitz in the west and the Rohrspitz somewhat further to the east.



Rhesi – flood protection on the Rhine

“Rhesi” is a flood protection project between Austria and Switzerland, and in this case stands for: Rhine – relaxation and security. Its objective is to provide the Rhine with space and people with increased protection against floods, as well as an increased number of leisure activities. Sustainable solutions are currently being worked out and discussed.

Green meadow: with irises and white storks
Right: Walter Niederer in front of the insect hotel of the Rheindeltahaus



Red sunset: reeds and small boats on the Rohrspitz in Fußach bay



Walter Niederer's tip for cyclists: the Rhine delta tour, about 20km in length, which follows the polder dam of Lake Constance, the Old and the New Rhine. The tour starts and ends in Fußsach. Walking tips for the winter include, in particular, the estuary of the New Rhine, since you can spot an especially large number of birds there during the cold season. You can take a walk along the two Rhine dams which take the water of the Rhine a way out into the lake itself. They were constructed to prevent the shore zones from silting up too quickly.

"The best thing of all is that you can access most of the nature reserve areas," says Ruth Swoboda from the inatura. Not only can you bathe in the Rheinholz – you can even barbecue in specially designated spots. If you are not there for pure relaxation purposes but rather to hone your view of the details of this constantly changing landscape, feel free to take any one of the numerous excursions offered, for instance, by the RheindeltaHaus in Fußsach.



The Rhine delta is home to 330 species of bird, 160 species of wild bee and around 600 plants

And suddenly you discover in the meadow not only white storks but maybe also a lapwing. You stroll not only through the green countryside, through the reeds, past willow trees. Now you can also see Siberian irises, marsh gladioli, sundew and the dwarf cattail. It is well-known that around 600 different species of plant grow in this paradise of nature. You can hear the croaking of frogs in the evening – however, nobody had picked up on the 160 species of wild bee living in the Rhine delta to date.

It is a lovely morning as we set off on the Rhine delta tour by bicycle. First of all we cycle along the Rhine dam, then along the polder dam. We cycle towards Rohrspitz, one of the two peninsulas in the nature reserve. There, we want to stop off for lunch at Salzmann in the harbour, try some fish freshly caught from the lake. The sky is pastel-coloured. It is still pleasantly cool at this time of day. We look out to the water. You can see every shade of blue in Lake Constance – as well as any amount of birds. Their twittering and song accompany us on our tour.



The Rhine delta on video



Experience the Rhine delta by scanning the QR code. Listen to Ruth Swoboda and Walter Niederer telling their stories.

More about the region:

www.bodensee-vorarlberg.com/naturschutzgebiet-rheindelta;
www.inatura.at; www.vorarlberg.travel/rheindelta-circular-path

Visit us on social media channels and post
your holiday impressions of Vorarlberg

#visitvorarlberg

#myvorarlberg

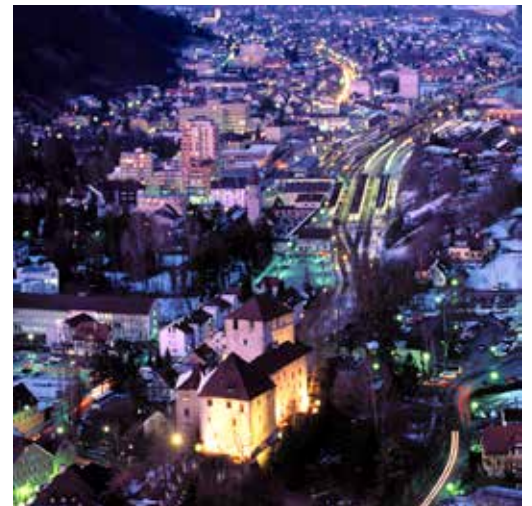
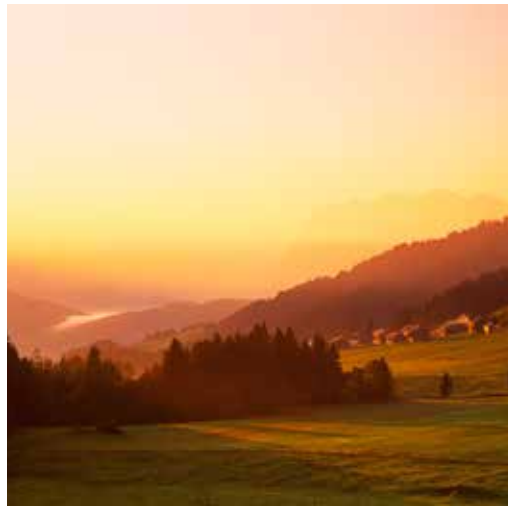

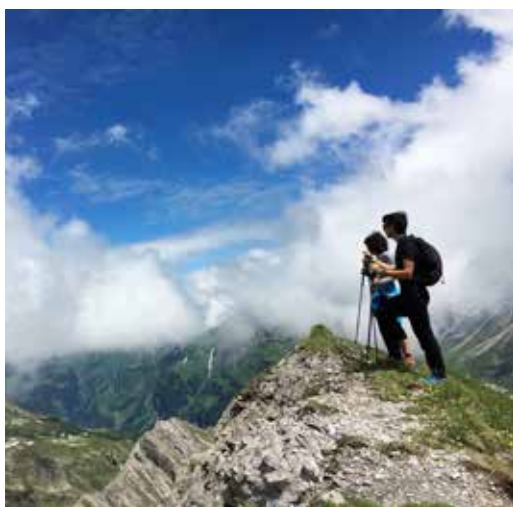

Vorarlberg is also represented on these websites. Check us out:

 **vorarlberg.travel**

 **facebook.com/ urlaubsland.vorarlberg**

 **instagram.com/ visitvorarlberg**

 **youtube.com/ myVorarlberg**

 **vimeo.com/ visitvorarlberg**

 **pinterest.com/ visitvorarlberg**

 **twitter.com/ visitvorarlberg**

 **visitvorarlberg. tumblr.com**

 **steller.co/ visitvorarlberg**

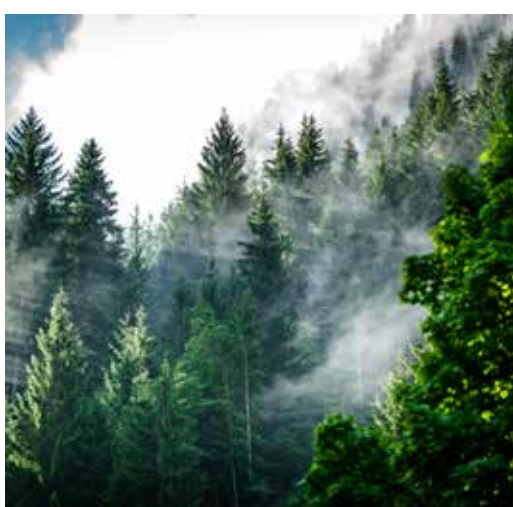



My favourite place

Sepp Mallaun is a ski instructor, a ski guide – and one of the best sports photographers in the Alps. His homeland, on the Vorarlberg side of the Arlberg, is also home to many unique natural beauty spots which he loves to photograph, especially in the winter. He presents one such spot here.

PHOTOS: SEPP MALLAUN TEXT: STEFAN HERBKE



Creating a stir: Sepp Mallaun photographed these freeriders above the mist-covered **Klostertal**. In the background: the **Rätikon** with the **Sulzfluh** and the **Drei Türme**



A favourite place may
be changeable, may at
times lie in the mist. «

Sepp Mallaun, photographer



Tracks in the snow:
Sepp Mallaun loves taking photos here, above the **Flexenpass on the Arlberg**. The hollow is close to the new Flexen cable car.



Sepp Mallaun about his favourite place:



“You can sit up here for an hour and just watch the light changing, watch one ridge of snow disappear in the shade and watch another one appear. You forget all about the cold and marvel at the miracle of Mother Nature. My favourite place is above the Flexenpassstraße, between Himmelegg and Ochsenboden, and it combines all the assets of the perfect photo spot. The hollow, approximately a hectare in size, is beautiful, it offers a great deal of different scenes, special atmospheres and, in the form of the Rätikon, a bizarre background. In the evening, once the skiers have left and the mist starts to settle in the Klostertal, I frequently await the evening light here.

Sometimes the mist rises too high and things get uncomfortable. To me, this is the proof that a good photo spot can also be changeable. On the other hand, I am rarely disappointed. I actually always go home with a good haul of photos. A great many fantastic photos, lovely experiences with friends and good memories – that is what I associate with this place I love returning to over and again.”

 www.lech-zuers.at/freeride





**The glow of the sun
on the Arlberg:** when
mist lies above the
Klostertal, enchanting
moods of the light
come into shape

Every shade of white imaginable – the colours of winter in Vorarlberg

A romantic night in an igloo, wild snow stories or an alpaca tour and a campfire to warm your cockles – even off the slopes guests can expect to actively enjoy everything the winter has to offer



1

A cross-country ski run for your balance

This is something you will only find in the Kleinwalsertal: all Walser Omgang-Vital cross-country ski runs are identified by one of the three stimuli Regeneration, Balance or Activation. Following a HRV (heart rate variability) test, which evaluates the rhythm of the beat of the heart and comes to conclusions about the level of vitality, you decide which type of course best promotes your personal well-being. The only place in the whole of Vorarlberg to offer this special type of health check-up is the Kleinwalsertal. The "Walser Omgang" is a programme of exercise and vitality for improving one's quality of life, state of health and level of performance.

www.kleinwalsertal.com

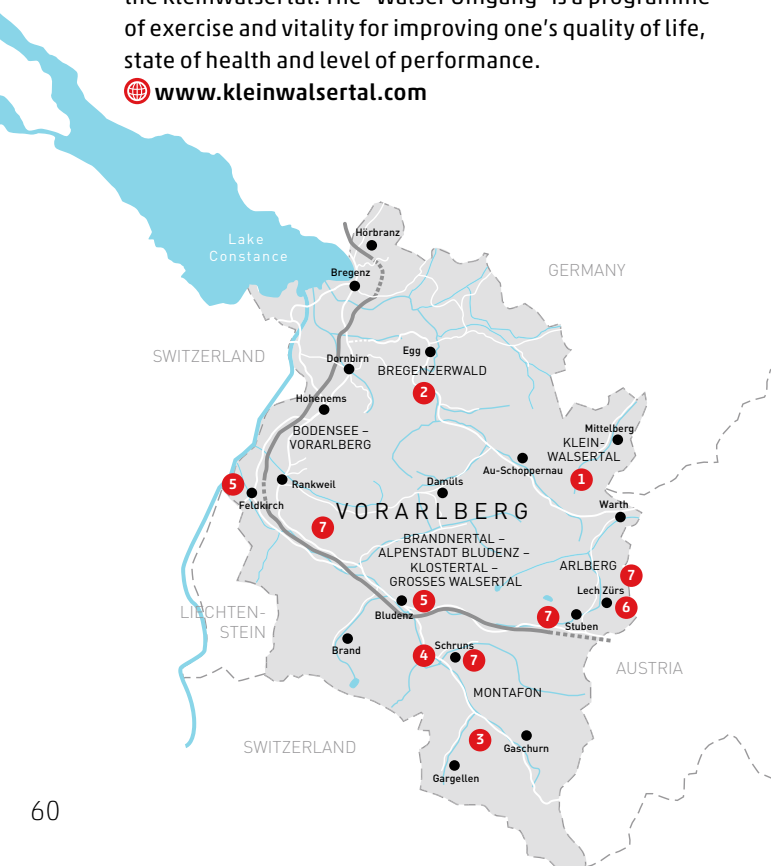

2

Following winter paths in the Bregenzerwald

A completely new experience: for three days, for four to five hours per day, you hike through selected, lovely winter landscapes and spend one night each in two different hotels. During the tours, you pass through homely villages and can visit sights such as the Werkraumhaus in Andelsbuch. The best thing about it: the winter hikers travel lightly, since their luggage is transported from place to place for them.

www.bregenzerwald.at/winter-hiking



3

A night in a snow igloo

Bearing torches, the participants hike through the crunchy snow in the Montafon as far as their accommodation located at an altitude of 2,300 metres. The guests can look forward to a campfire with glühwein and cheese fondue served on a dining table made from snow. Snug as a bug in a warm sleeping bag, with fleeces for added warmth, the guests spend the night there in the wintery mountains. The next morning, they proceed to the nearby Valisera Hüsli for breakfast.

www.montafon.at/winter



4

For kids that can master a parallel turn

If the word safari brings to mind lions and elephants, you will get a shock at the kids' skiing safari on the Golm in the Montafon! The exciting adventure tour starts with a downhill run in the deep snow. Stories from the wintry wilderness, puzzle solving and a barbecue party ensure good cheer. 🌐 www.montafon.at/winter

5

Through the lovely old alleyways

Carrying a lantern and attired in a historic costume, the night watchman leads the way. He takes guests to historic and romantic spots in the old town of Bludenz, telling them tales from times gone by along the way. The walk takes around 1.5 hours (held weekly and by arrangement). A night watchman in Feldkirch also accompanies interested parties through the alleyways of the medieval town. 🌐 www.bludenz.travel



6

Where does the snow come from?

The curious are afforded the chance to take a peek behind the scenes of the winter operations in Lech Zürs am Arlberg. Once a week, a journey of discovery takes skiers to various stations in the skiing area. There, they find out how a cable car or a chair lift works. Employees of Lech ski lifts can describe the artificial snow-making equipment, the snow crawler and the avalanche protection if called upon to do so. 🌐 www.lechzuers.com



7

Exploring the wintry mountains with alpacas

A great adventure for the old and young alike: Birgit Knecht from Röns specialises in tours with alpacas and campfires. Similar offerings are also available in Bartholomäberg, Lech Zürs am Arlberg and in the Klostertal. 🌐 www.alpenregion-vorarlberg.com; www.montafon.at/winter

Heaven on earth

It was during a hike around Lech am Arlberg that the world-famous artist James Turrell was so taken by the mountains that one of his Skyspaces is now being realised precisely here – a space in which light is experienced anew

TEXT: THOMAS ZWICKER

PHOTOS: MARIA MUXEL, FLORIAN HOLZHERR, DAVID HEALD





Artist on the mountain:
James Turrell
at the location
Tannegg close to
Lech am Arlberg.
His Skyspaces
play with space
and light.

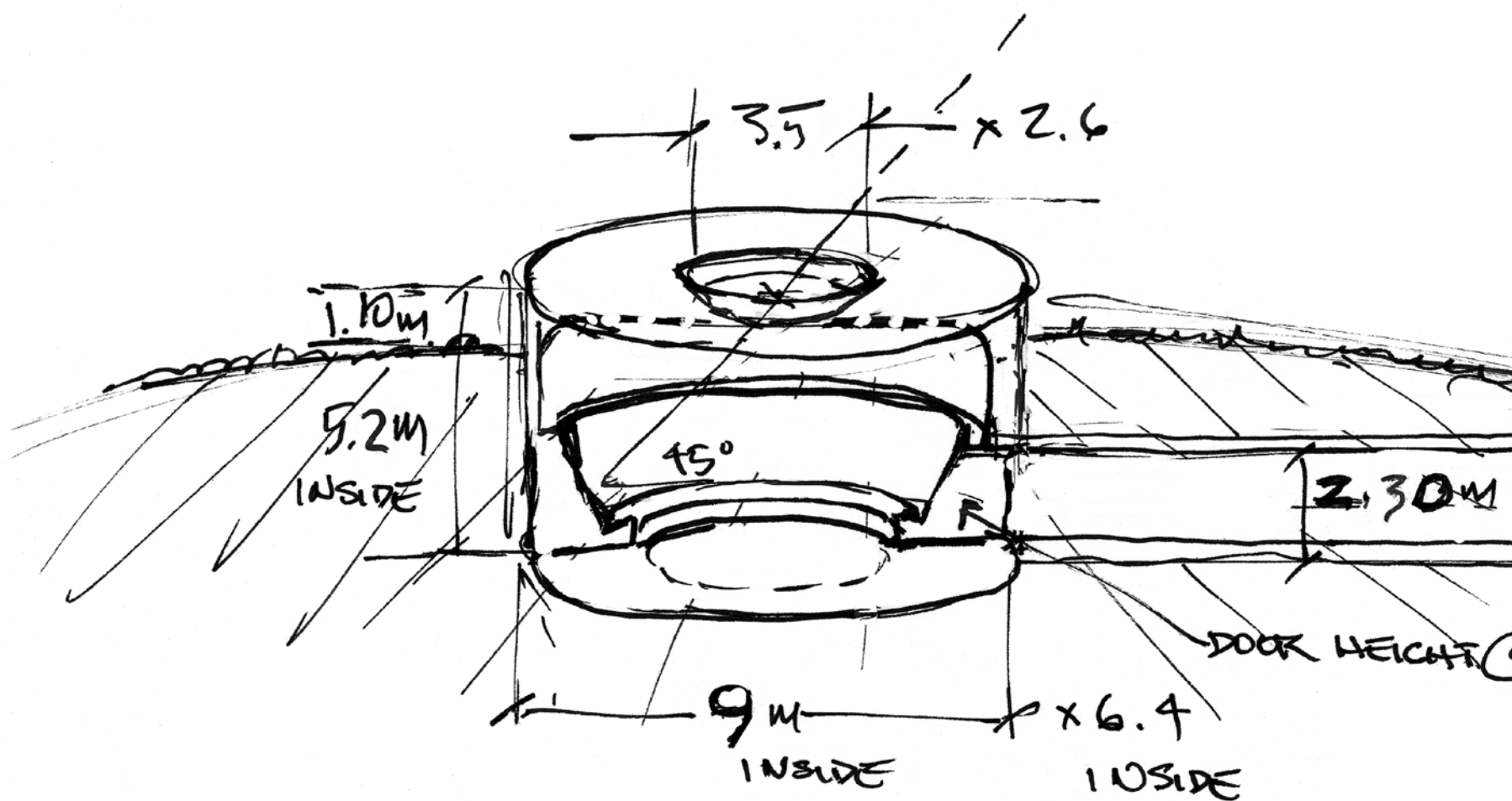

The air up here is crystal clear and wonderfully fresh. A salutary tranquillity reigns above the Tannegg hill, a small, almost perfectly formed cone at an altitude of 1,780 metres above sea level, close to the Schlosskopf cable car high above Lech am Arlberg. All around, a powerful mountain landscape, with the Biberkopf, Karhorn, Mohnenfluh and Omeshorn towering heavenwards. In its isolation, the Tannegg appears rather as if it has been left behind in time, an energy location with an enchanting view where the hiker stops to pause for a moment. And which is set to soon act as the stage for one of the great works of art of our time.

“Little light reaches here from the village, making it the perfect place for installing a Skyspace,” says Ludwig Muxel, Mayor of Lech, who explains and points and shapes the planned project with his hands in such an enthusiastic, impassioned way that the work of art almost becomes visible. The tranquillity of the place, the contrast with the frequently turbulent hustle and

bustle of the holiday season in Lech – both in summer and winter – are of major importance to Ludwig Muxel. “Culture is very, very important to us,” says the mayor. “Not only for the guests, but for us locals too.”

The large-scale “iron men” by Antony Gormley were only the beginning

Culture in the lovely natural countryside around Lech Zürs am Arlberg has had its place for quite some time now. It was in 2010 that the Kunsthaus Bregenz realised a massive landscape installation known as “Horizon Field” with Antony Gormley, one of the most significant contemporary sculptors in Great Britain. Exactly 100 life-size iron figures were erected over an area of 150 square kilometres in the Lechquellengebiet of Vorarlberg, each at an altitude of 2,039 metres. They were complemented by maps of the locations, project descriptions, recommended hikes, talks and workshops. An art project in public space which, it may be said, caused an international sensation.

The precise dimensions:
the Skyspace in Lech in a sketch by Turrell

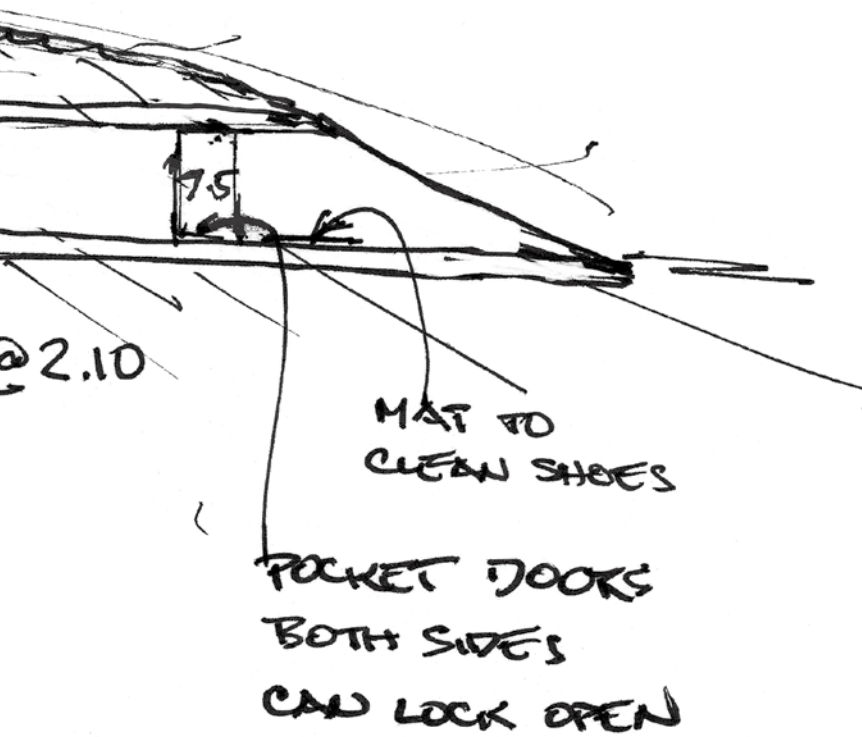

Biography of James Turrell



Born in Los Angeles in 1943, initially James Turrell studied psychology and mathematics, and finished his studies in art in 1973. Since the 1960s, he has been working on so-called "light spaces" and, with this, has been examining the manifold manifestations of light, both natural and artificial. Installations and

environments enable light to be experienced as an artistic medium, with area, colour and space entering into an electric interplay, making the light sensory, bringing it intellectually up-close.

Since the 1970s, the artist has been working on his life's work, the dormant volcano "Roden Crater" in Arizona with its tunnels, subterranean rooms and ceiling openings to the sky. In the form of his work "Aten Reign", in 2013 he converted the Solomon R. Guggenheim Museum in New York into an atmospheric light space. This was followed by major retrospectives in the Los Angeles County Museum of Art (LACMA) and the National Gallery of Australia. In total, Turrell has realised over 140 individual exhibitions in museums and galleries as well as over 60 Skyspaces worldwide.



Rotunda: the "Piz Utor" Skyspace in Zuoz, Switzerland

Vista: sculpture from Horizon Field, the preceding project (below)



Gormley's idea of integrating culture in nature was enthusiastically received – thousands of hikers and skiers came to admire the iron men in the mountains. According to their creator, the figures represent a "deep association between the social and the geological space, between landscape and memory." Horizon Field, the art association established in Vorarlberg, logically set itself the objective of continuing the project originally intended to end in 2012 and to leave the 100 alpine sculptures as permanent installations. This plan failed, and almost all of the 640-kilogram heavyweights were taken down, and only one final iron man is still standing watch above the Kriegeralpe.

Since the locals of Vorarlberg are not known for their whining, but rather for their positive thinking and getting on with things, the association soon decided to launch a follow-up project with another internationally renowned artist. Working in cooperation with the local gallery owner Wolfgang Häusler (from Galerie Häusler Contemporary), the American light artist James

Turrell was gained for the Skyspace venture in Lech. Under the management of doers such as Otto Huber (chairman) and Artur Vonblon (finances), the Horizon Field association came to an agreement with the landowners, obtained approvals, and worked on the finances. The Skyspace Lech project started to take shape.

James Turrell isn't an unknown in Vorarlberg: he illuminated the opening exhibition of the Kunsthaus Bregenz with his light installation in the façade back in 1997. It was at the invitation of the Horizon Field association that Turrell came to the mountains of Vorarlberg in September 2014, taking a hike to search for a suitable place for one of his Skyspaces, including to the Tannegg via Oberlech. The strapping man with a snow-white beard and bushy eyebrows was fascinated by this mountain landscape from the word go, soon acknowledging

» My Skyspaces lower the sky down to the level of the ceiling of a room. «

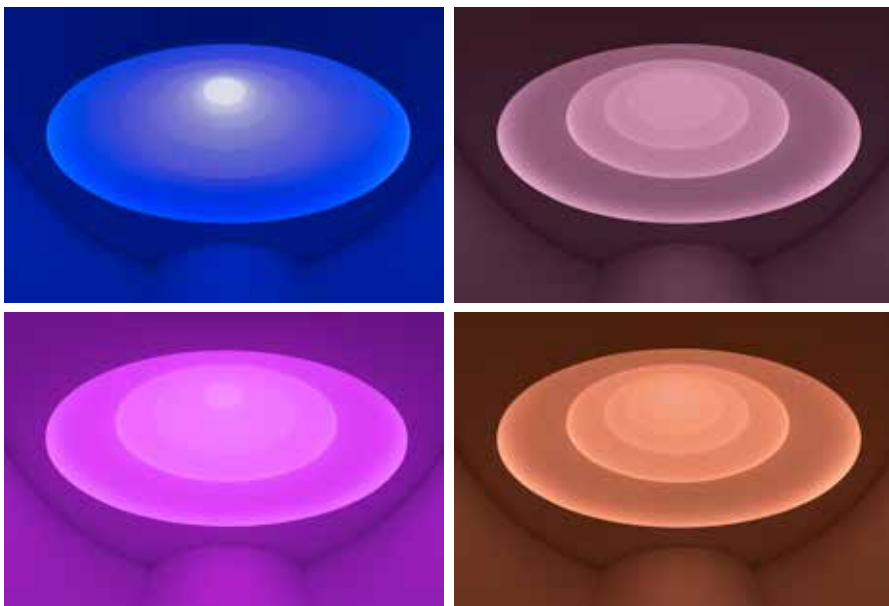

Light painting: interplay of colours of the "Aten Reign" work in the Solomon R. Guggenheim Museum, New York

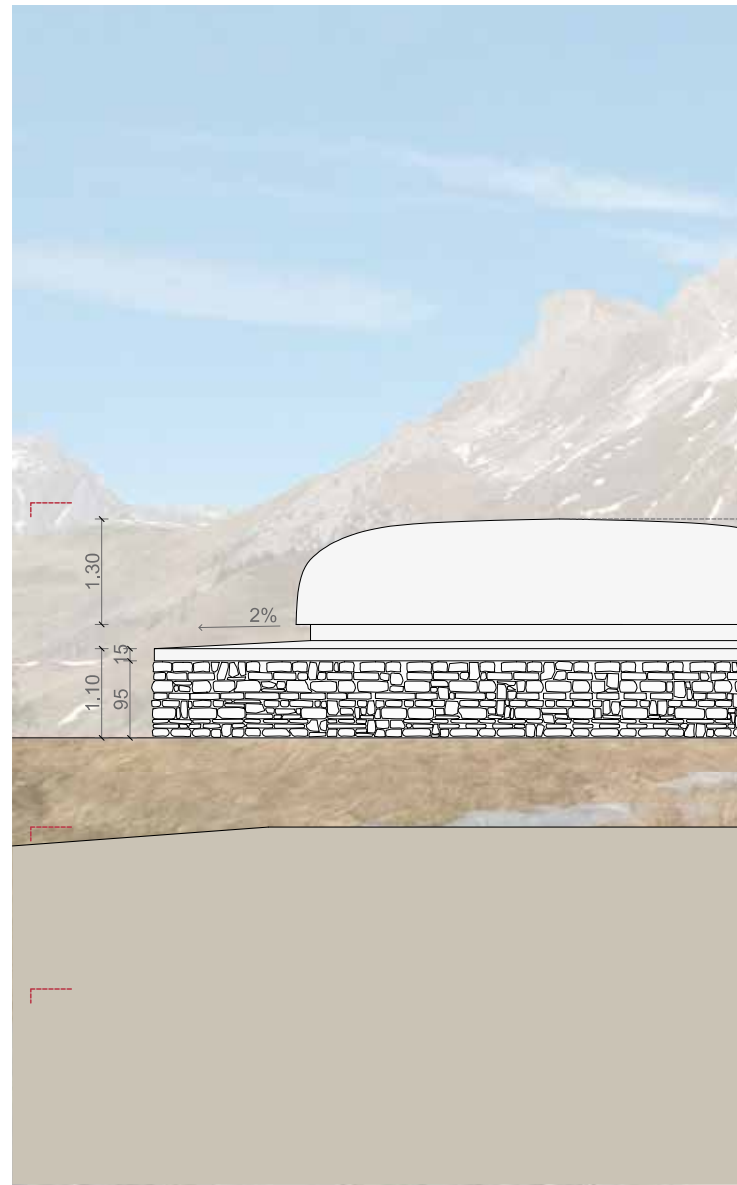

the Tannegg as a place excellently suited for a very special Skyspace. The artist quickly produced the first sketches for the project which is now being realised by the renowned Baumschlager-Eberle firm of architects with the objective of connecting landscape, nature and culture.

James Turrell has realised about 60 different Skyspace projects around the world to date

The Skyspaces by James Turrell are specially proportioned spaces into which the light falls via an opening in the ceiling. Some of them are integrated in existing buildings, some of them have been erected separately. "We often look to the sky and think to ourselves how far away it is. Yet my Skyspaces lower the sky to the level of the ceiling of the room you find yourself in," according to the American. "Roden Crater", the most spectacular of his projects to date, is a massive, dormant volcano close to Flagstaff in Arizona which Turrell has been turning into a gigantic light art project



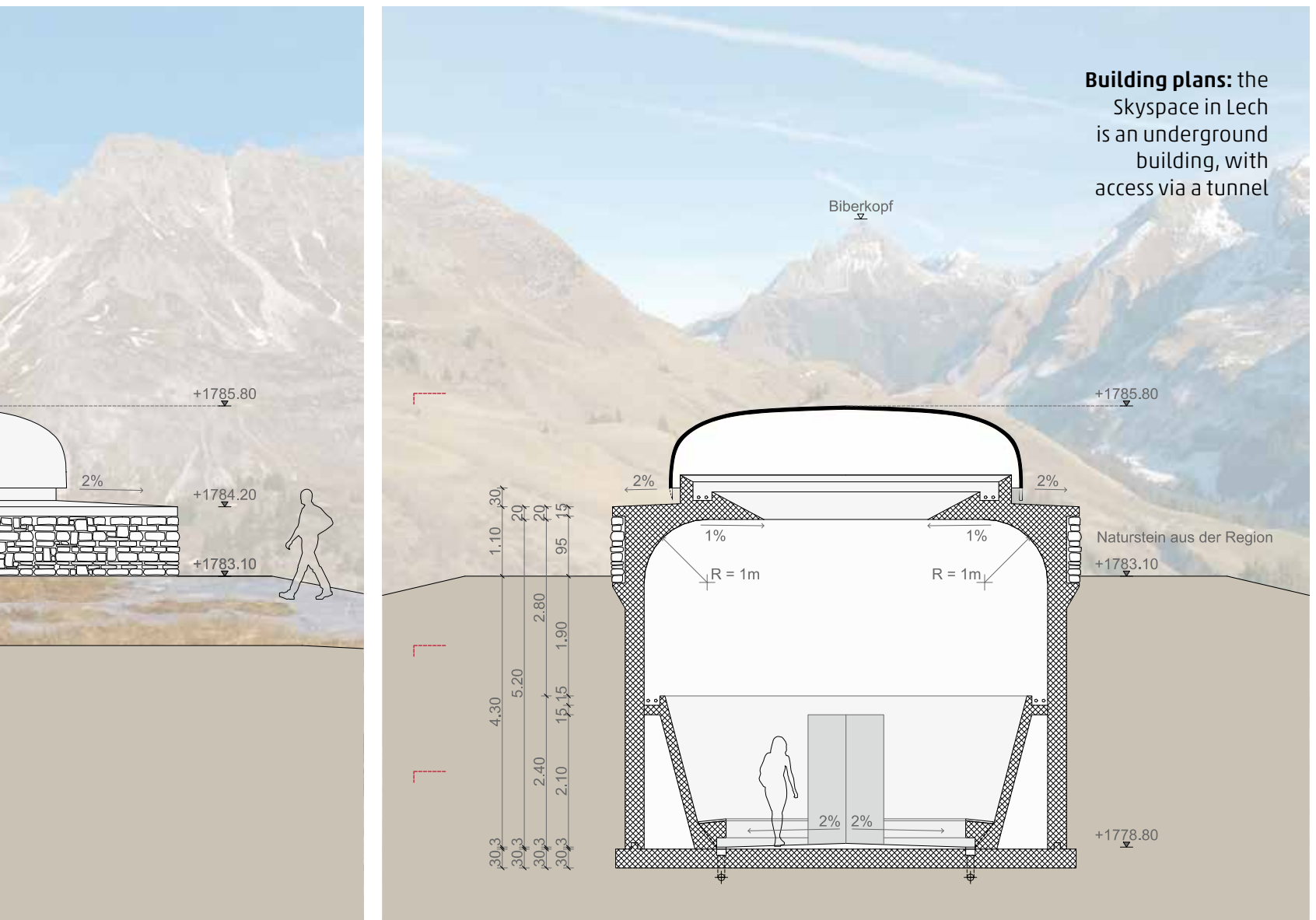

Building plans: the Skyspace in Lech is an underground building, with access via a tunnel

since 1974, in the form of shafts and tunnels cut into the volcano including openings directed towards the sky. There are currently 60 smaller Skyspace objects all over the world, and the work of art in Lech am Arlberg will fit in to the features of the village in the Alps.

Turrell's plan intends on installing the work of art mainly underground, inside the peak. A tunnel 15 metres in length provides access to the oval-shaped main room which measures 6 x 9 metres, is 5.20 metres high and has space for approx. 30 visitors. The oval opening in the ceiling has a cupola which can be moved and, depending on the weather and the incidence of light, provides various perceptual effects. Phenomenal impressions are anticipated particularly at dusk. Additionally, three light installations generate variable colour moods.

The Skyspace Lech will be hardly recognisable from the outside: great care is taken to perfectly integrate it in the surrounding nature. As a room of silence, as a space for slowing down and relaxing – it is already

appreciated as these things. “What interests me is the effect of the light on you and your sense of perception,” the artist once said in an interview, adding, “you are flying through something that is almost fluid, the air turns into material, a brilliant, intensely glowing material.” If everything goes according to plan, locals and holiday-makers alike will be able to experience this mystical sensation in Lech before the end of 2017, following inauguration of the work of art.

Three doers of the Skyspace on video



Ludwig Muxel, Otto Huber and Artur Vonblon talk about the work of art – simply scan the QR code.

Further information about the project is also available at

www.skyspace-lech.com



Nature's flowerpot:
Small plants flourish
in many grooves in the
rock of the Gottesacker
plateau, such as here,
the mountain valerian

In the labyrinth of stones

Ernst Haller has been hiking all of his professional life, and almost all of his lifetime, preferably in the Kleinwalsertal, where he was born and bred. He told us his story – and much more – during a hike to the Gottesacker plateau.

TEXT: ANNE SCHÜSSLER PHOTOS: DIETMAR DENGER, FRANK DRECHSEL, HANS WIESENHOFER





Taking a hike together: Ernst Haller, mountain guide, enjoys sharing his massive wealth of knowledge with others

Discover: the path to the Gottesacker plateau meanders through green hills and colourful flower meadows



It is with a resolute, brisk step that Ernst Haller walks ahead. The path up the mountain is a sea of small, sharp bends. The path is narrow and stony, yet Ernst advances as if he knew every stick and every stone of it. His gaze wanders across the countryside and far down into the valley which, this morning, is still nestled under a thick blanket of clouds as if it were having a lie-in.

Ernst Haller, on the other hand, is full of beans. The 80-year-old is a mountain guide in the Kleinwalsertal, and today is accompanying us to the Gottesacker plateau. This unique karst landscape, which is under conservation, lies to the north of the Hoher Ifen and the best way to get there is by the Ifen cable car. Over the course of millions of years, the water has cut conspicuous grooves and clefts out of the limestone. The water also seeps through cracks deep into the limestone, cutting out numerous karst caves on the plateau. This is what shaped this unique rock

formation which is home to many species of plant: alpine rose, mountain avens, black and red nigritella fragrant of vanilla, juniper, herb Paris, Michaelmas daisy, spring gentian, cotton grass and chives – all of them thrive here, under the Ifen. Nobody is really sure how the plateau got its name. According to one legend, a beggar on an alp asked its owners for some lard. However, underneath a thin layer of lard there was only muck in the container. As retribution, God punished the dairy farmer and his family for ridiculing the beggar – the alpine pasture was transformed into this rocky landscape.

Ernst Haller regularly hiked on his parents' alp as a little boy

As we climb higher and higher, the clouds come in thicker and thicker. We are surrounded by a white wall which seems to cut us off from the rest of the world, just like a massive wad of cotton wool. The



Barren, fascinating:
the view across the
Gottesacker plateau

Out and about in the Kleinwalsertal

Hiking in the Kleinwalsertal is generally at an altitude of between 1,100 and 2,500 metres. Up high, the peaks of the Großer Widderstein (2,536 metres), the Kanzelwand (2,058 metres) and the Hoher Ifen (2,229 metres).

The ascent to the Schwarzwasser hut including a visit to the Melköde alp, under landscape protection, is a unique, very special hike.

 www.vorarlberg.travel/hike-schwarzwasserhuette



only thing we can see is the landscape just ahead of us, and it is beautiful – green, lush meadows, and from the distance we can hear the ringing of the cow bells. Small drops of dew glitter on the flowers on the side of the path. “I particularly love these moments of tranquillity,” explains Ernst Haller. He has been hiking and climbing mountains all over the world for over 70 years. Once upon a time it was a necessity. Then it became a job. Now it is a passion. Even as a little boy he had to regularly hike up to his parents’ alp, look after the cattle and fetch cream. “These errands allowed me to live with and to experience nature, and I can still remember the hikes, like today in the mist. I loved it even back then,” he says.

The further we advance, the more fascinating the countryside becomes: huge cliffs tower above us, covered with mosses and meadow herbs. Rivulets and puddles of water now appear out of the ground. Black alpine salamanders crawl out of their hiding places.



No tour is like any other tour – even if you are doing it for the hundredth time. «

Wrapped in cotton wool: this morning, the Kleinwalsertal lies underneath a blanket of clouds



The world of small things: on the stones, we discover black alpine salamanders and beautiful flowers

Cute they are, and don't mind us taking a good look at them. "Yes, they are rare," says Ernst, who appears to be rather amused at our enthusiasm – naturally, he has seen loads of them in his time.

And then the seasoned mountain guide suddenly turns off the path and takes us across country. Nimble, the man climbs over the rocks, seemingly oblivious to scree and holes. "As I get older, I like to take advantage of hiking to chill out, and I take pleasure in nature. The monotony of the exercise frees me," he tells us. Then he stops on a ledge. We catch up with him and take a look at the landscape in front of us in amazement. We have reached the plateau.

A grey desert of rocks opens up in front of us. The rock is marked with deep fissures and cracks. In parts, it shines black from the rain. Small ferns grow upwards out of the grooves – otherwise, there is a distinct absence of plant life. The low-hanging clouds give the setting a mystic undertone. The only sounds are from the steady splashing and the dripping of the water.

Rapt, we sit on a wooden bench leaning against the wall of the hut and enjoy the complete silence.

We slowly advance across the karst landscape, with Ernst Haller at the front. We would undoubtedly have got lost without him. Now and again we throw a stone into one of the cracks just to see how far down it goes. Upshot: we really don't want to fall down any of them! And so we climb on carefully.

We are worn out by the time we reach the closed hut of the Hahnenköpfe cable car. Climbing over the rocks is tiring. It is with a sense of gravity that Ernst tells us, "You really shouldn't embark on a tour like today's without a mountain guide," whilst we fortify ourselves with the sandwiches we have brought with us. "Also, you need to bring plenty to drink with you. There is nothing after the Ifen hut, and it takes hours to fully cross the plateau."

Rapt, we sit on a wooden bench leaning against the wall of the hut and enjoy the complete silence. Ernst is smiling contentedly, and now we understand what it is that has been driving him up the mountains for 70 years. It is moments like these.



Mountain guide Ernst Haller on video



Scan the QR code to experience a hike to the Gottesacker plateau with Ernst Haller. You can reserve a tour with the guide and ski instructor at: www.bergschule.at

Further information about the presented tour available from:

www.vorarlberg.travel/hike-gottesacker



Information and travel arrangements

Here is an overview of everything you need for planning and reserving your holiday in Vorarlberg

Six regions full of diversity

Vorarlberg is 100km long from north to south, and the great diversity in its scenery is impressive. An hour's drive from the Mediterranean-like shore of Lake Constance at an altitude of 400 metres via gently undulating hills takes you to the high mountains. Nature and lifestyle bestow each of the six holiday regions with a character of their own.

Vorarlberg interactive

Practical aids are available for the preparation of hikes and to help you find your way around once you get there. Interactive maps on www.vorarlberg.travel describe numerous paths in detail. The information about all routes can be downloaded and printed out. Via "layers", you can add further information, from sights through to restaurants, from photos through to bus stops.

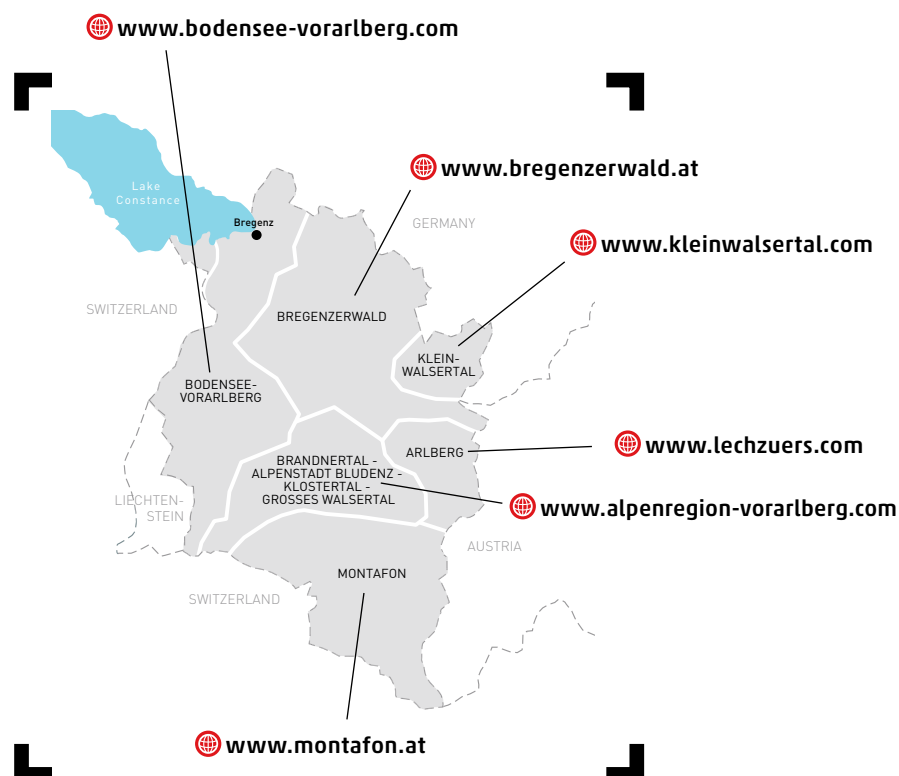

Information and booking

If you have any questions regarding the planning of your holiday or require further information about any of the topics, please contact Vorarlberg Tourismus directly. You can also order brochures directly from the website:

www.vorarlberg.travel

T +43.(0)5572.377033-0



#visitvorarlberg #myvorarlberg

Vorarlberg Tourismus

Poststraße 11, Postfach 99, 6850 Dornbirn, Austria
info@vorarlberg.travel



Travelling to Vorarlberg

Vorarlberg is easy to reach by all traffic routes and all modes of transport. The public transport network is well developed.

www.vorarlberg.travel/getting-there

... by car

Coming from the north via Singen-Lindau or Singen-St. Gallen, via Ulm-Lindau. Via Augsburg or Munich-Lindau or via Nuremberg-Lindau. **Coming from the west** via Zurich-St. Gallen or Zurich-Walensee-Sargans. **Coming from the south** via Como-San Bernadino-Chur, Brenner-Innsbruck or Reschenpass-Landeck. **Coming from the east** via Innsbruck-Arlberg or via Reutte-Bregenzerwald (please note: the L 198 Lechtal Straße from Warth to Lech is usually closed in winter). **The Kleinwalsertal** can be reached on the A 7 via Immenstadt and, further, via Sonthofen and Oberstdorf.

... by train

Austria: www.oebb.at; **Germany:** www.deutschebahn.com and www.dbautozug.de; **Switzerland:** www.sbb.ch

... by air

The closest airports (distance to Bregenz): **Bodensee-Airport Friedrichshafen** (D, 35 km), **St. Gallen-Alttenrhein** (CH, 20 km), **Allgäu-Airport Memmingen** (D, 77 km), **Zurich** (CH, 119 km), **Innsbruck** (A, 184 km)

IMPRINT Publisher: Vorarlberg Tourismus GmbH, Poststraße 11, 6850 Dornbirn, Österreich

Concept, editing, design: Cross Media Redaktion Buchholz, www.cross-media-redaktion.de; Joachim Negwer, Maja Schollmeyer, Christiane Würtenberger, Thomas Zwicker, Anne Schüßler. **Editorial office:** Nadia Al Kureischi; **Photos:** Cover: Dietmar Denger; *Content* (p.3): D. Denger (3); *Enjoyment of nature* (p.4): D. Denger (10); Lech Zürs Tourismus GmbH (p.4), Darko Todorovic (p.12); *Gallery* (p.16): D. Denger (1), Vorarlberg Tourismus/D. Walser (1), Hohentwiel/Mende1@Hohentwiel (1), Dornbirn Seilbahn GmbH (1), O. Farys (1); *Meadow Championship* (p.20): D. Denger (12); *Reinhard Haller* (p.28): Hofmeister; *The power of water* (p.30): D. Denger (10); *Shakespeare on the Mountain* (p.38): D. Todorovic (10); *Culture tips* (p.44): Montafon Tourismus GmbH/A. Haller (1), www.peterrigaud.com (1), Kleinwalsertal Tourismus eGen (1), Erlebnis Naturschau/N. Gorbach (1); *Rhine delta* (p.46): J. Negwer (8), A. Mende (1); *Social media* (p.52): D. Denger (6), Vorarlberg Tourismus (4), Popp & Hackner/Vorarlberg Tourismus (2), Markus Gmeiner (1), O. Noggler/Vorarlberg Tourismus (1), L. Berchtold (1), A. I. Schnabel (1); *Winter* (p.54): Sepp Mallaun (4); *Tips for the winter* (p.60): Kleinwalsertourismus/F. Drechsel (1), Daniel Hug www.terragraphy.de (1), Bludenz Stadtmarketing GmbH (1), Ski Arlberg, alpaca-lama.com/B. Knecht; *Skyspace* (p.62): Maria Muxel (p.62); Skyspace „The color inside“ University of Texas, Austin, 2012 © James Turrell Foto: Holzherr (p.63); Entwurfsskizzen © James Turrell (p.64), Konzept skyspaceLech Courtesy Horizon Field – Kunstverein Vorarlberg; Skyspace „Piz Uter“, Zuoz © James Turrell Courtesy: Häusler Contemporary München | Zürich Foto: Holzherr; Ludwig Berchtold/Vorarlberg Tourismus; Pläne (p.66 +67) Planmappe © James Turrell, Konzept skyspaceLech © Baumschlagler-Eberle Architekten, Planung skyspaceLech Courtesy Horizon Field – Kunstverein Vorarlberg; Fotos Installation Guggenheim Museum James Turrell, »From the Guggenheim, Aten Reign«, Foto David Heald © James Turrell Courtesy Häusler Contemporary München | Zürich; *Gottesacker plateau* (p.68): D. Denger (8), Kleinwalsertal Tourismus/F. Drechsel (p.69), Kleinwalsertal Tourismus/H. Wiesenhofer (p.71), P. Mathis/Vorarlberg Tourismus (p.71), *Reverse*: Sepp Mallaun **Translation:** Proverb – M. Maibach; **Lithography:** Laudert, Hamburg; **Print:** Buchdruckerei Lustenau GmbH, Lustenau

All information is based on supplied documents. Despite careful editing, the information provided does not provide any guarantee of accuracy. All information as per January 2017.

As white as snow. Enjoyment of nature in Vorarlberg.

Mountains covered in deep snow, air as clear as a bell, sky blue as far as the eye can see – when the winter comes to Vorarlberg and casts its spell on its countryside, then it is time for magic moments. Out and about, you encounter ancient craftsmanship, timeless architecture and people who both love tradition and are receptive to the new. Experience for yourself the beauty of winter in the mountains – as a backcountry skier, a skier, a hiker of the wintry landscape. Or quite simply as a lover of nature.



Vorarlberg Tourismus

Postfach 99, 6850 Dornbirn, Austria

T: +43.(0)5572.377033-0, F: +43.(0)5572.377033-5

info@vorarlberg.travel, www.vorarlberg.travel

Austria } **VOR
ARL
BERG**